

1A Ultra-Low Dropout Voltage LDO Regulators with Soft-Start

1 General Description

The RTQ2551A-QA is a very low dropout linear regulator that operates from an input voltage as low as 0.8V. The device is capable of supplying 1A of output current with a typical dropout voltage of only 50mV. A VBIAS supply is required to run the internal reference and LDO circuitry while output current comes directly from the VIN supply for high-efficiency regulation. User-programmable soft-start limits the input inrush current and minimizes stress on the input power. The enable input and power-good output allow easy sequencing with external regulators. This complete flexibility provides an easy-to-use robust power management solution for a wide variety of applications.

The RTQ2551A-QA is stable with an output capacitor greater than or equal to 2.2μF. A precise reference and error amplifier deliver 1% accuracy over load, line and temperature. Overcurrent limit and over-temperature protection are also included. The RTQ2551A-QA is available in the WDFN-10L 3x3 package.

The recommended junction temperature and ambient temperature ranges are -40°C to 125°C.

2 Features

- **AEC-Q100 Grade 1 Qualified**
- **Ultralow VIN Range: 0.8V to 5.5V**
- **VBIAS Voltage Range: 2.7V to 5.5V**
- **VOUT Voltage Range: 0.8V to 3.6V**
- **Low Dropout: 50mV Typical at 1A, VBIAS = 5V**
- **1% Accuracy Over Line/Load/Temperature**
- **Power-Good Indicator for Easy Sequence Control**
- **Programmable Soft-Start Provides Linear Voltage Startup**
- **Stable with Any Output Capacitor ≥ 2.2μF**
- **Overcurrent and Over-Temperature Protection**

3 Applications

- PCs, Servers, Modems, and Set-Top Boxes
- FPGA Applications
- DSP Core and I/O Voltages
- Instrumentation
- Post-Regulation Applications
- Applications With Sequencing Requirements

4 Simplified Application Circuit

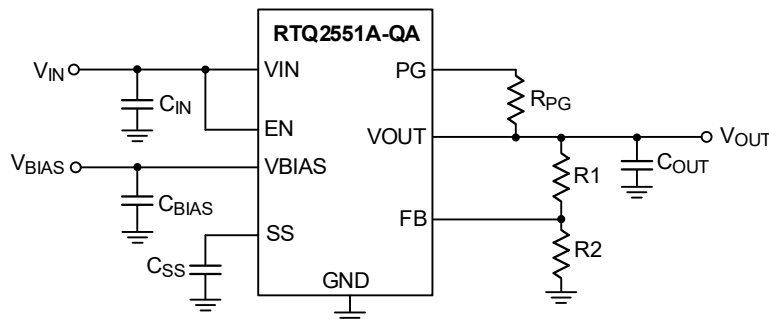

5 Ordering Information

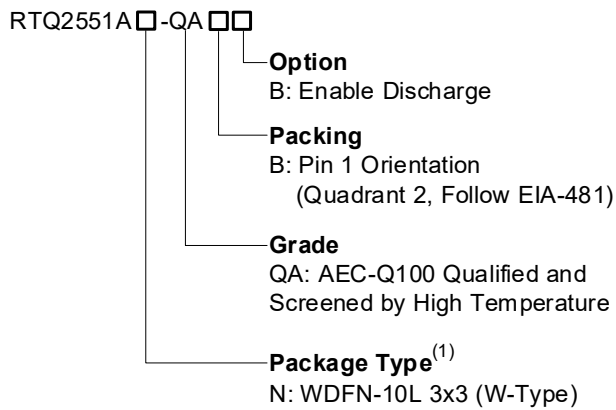

Note 1.

Richtek products are Richtek Green Policy compliant and marked with ⁽¹⁾ indicates compatible with the current requirements of IPC/JEDEC J-STD-020.

6 Marking Information

RTQ2551AN-QAB

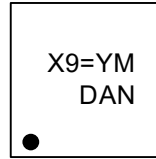

X9=: Product Code
YMDAN: Date Code

RTQ2551AN-QABB

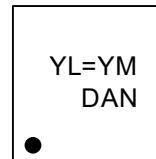

YL=: Product Code
YMDAN: Date Code

Table of Contents

1	General Description	1	17	Application Information	13
2	Applications	1	17.1	Dropout Voltage-----	13
3	Simplified Application Circuit	1	17.2	Input, Output, and Bias Capacitor Selection-----	13
4	Ordering Information	2	17.3	Adjustable Output Voltage-----	13
5	Marking Information	2	17.4	Power Up Sequence Requirement-----	13
6	Pin Configuration	4	17.5	Thermal Consideration-----	14
7	Functional Pin Description	4	17.6	Layout Considerations -----	14
8	Functional Block Diagram	4	18	Outline Dimension	16
9	Absolute Maximum Ratings	5	19	Footprint Information	17
10	ESD Ratings	5	20	Packing Information	18
11	Recommended Operating Conditions	5	20.1	Tape and Reel Data-----	18
12	Thermal Information	5	20.2	Tape and Reel Packing -----	19
13	Electrical Characteristics	6	20.3	Packing Material Anti-ESD Property-----	20
14	Typical Application Circuit	8	21	Datasheet Revision History	21
15	Typical Operating Characteristics	9			
16	Operation	11			
	16.1 VIN and VBIAS Supply-----	11			
	16.2 Enable and Shutdown-----	11			
	16.3 Output Active Discharge-----	11			
	16.4 Soft-Start-----	11			
	16.5 Power-Good Indicator-----	11			
	16.6 Overcurrent Protection-----	11			
	16.7 Over-Temperature Protection-----	12			

7 Pin Configuration

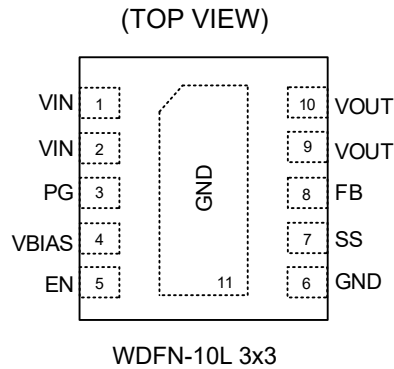

8 Functional Pin Description

Pin No.	Pin Name	Pin Function
1, 2	VIN	Power input of the device.
9, 10	VOUT	Regulated output voltage. A minimum of 2.2 μ F capacitor should be placed directly at this pin.
3	PG	Power-good indicator. An open-drain, active-high output that indicates the status of VOUT. A pull-up resistor from 10k Ω to 1M Ω should be connected from this pin to a supply of up to 5.5V.
4	VBIAS	Bias input pin. Provides input voltage for internal control circuitry.
5	EN	Chip enable (Active-High). Pulling this pin below 0.4V turns the regulator off, reducing the quiescent current to a fraction of its operating value. Connect to VIN if not used.
6, 11 (Exposed Pad)	GND	Ground. The Exposed Pad must be soldered to a large PCB and connected to GND for maximum power dissipation.
7	SS	Connect a capacitor between this pin and the ground to set the soft-start ramp time of the output voltage.
8	FB	Feedback pin. Connect this pin to an external voltage divider to set the output voltage.

9 Functional Block Diagram

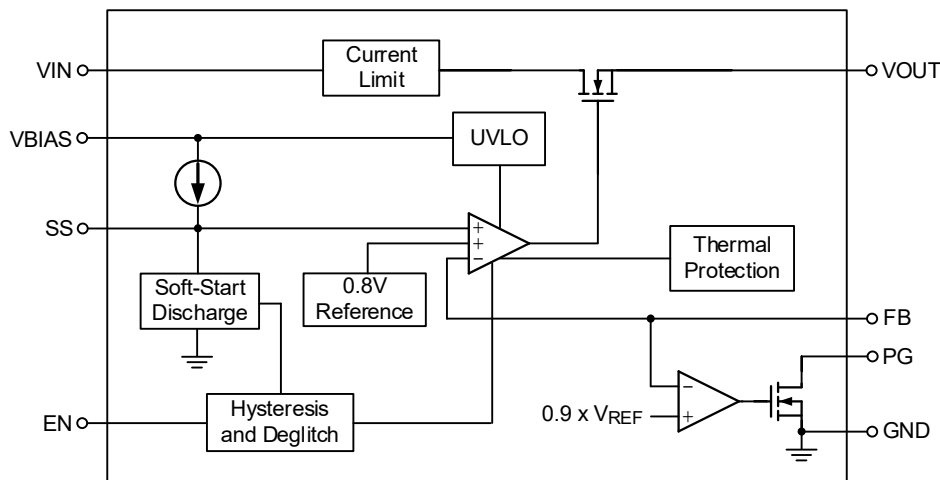

10 Absolute Maximum Ratings

(Note 2)

- Supply Input Voltage, VIN ----- -0.3V to 6V
- Other Pins ----- -0.3V to 6V
- Output Voltage, VOUT ----- -0.3V to 6.3V
- Lead Temperature (Soldering, 10 sec.) ----- 260°C
- Junction Temperature ----- 150°C
- Storage Temperature Range ----- -65°C to 150°C

Note 2. Stresses beyond those listed under “Absolute Maximum Ratings” may cause permanent damage to the device. These are stress ratings only, and functional operation of the device at these or any other conditions beyond those indicated in the operational sections of the specifications is not implied. Exposure to absolute maximum rating conditions may affect device reliability.

11 ESD Ratings

(Note 3)

- ESD Susceptibility
HBM (Human Body Model) ----- 2Kv

Note 3. Devices are ESD sensitive. Handling precautions are recommended.

12 Recommended Operating Conditions

(Note 4)

- Supply Input Voltage, VIN ----- 0.8V to 5.5V
- Junction Temperature Range ----- -40°C to 125°C
- Ambient Temperature Range ----- -40°C to 125°C

Note 4. The device is not guaranteed to function outside its operating conditions.

13 Thermal Information

(Note 5 and Note 6)

Thermal Parameter		WDFN-10L 3x3	Unit
θ_{JA}	Junction-to-ambient thermal resistance (JEDEC standard)	40.4	°C/W
$\theta_{JC(Top)}$	Junction-to-case (top) thermal resistance	70.4	°C/W
$\theta_{JC(Bottom)}$	Junction-to-case (bottom) thermal resistance	13.6	°C/W
$\theta_{JA(EVB)}$	Junction-to-ambient thermal resistance (specific EVB)	41.5	°C/W
$\Psi_{JC(Top)}$	Junction-to-top characterization parameter	1.5	°C/W
Ψ_{JB}	Junction-to-board characterization parameter	25.2	°C/W

Note 5. For more information about thermal parameter, see the Application and Definition of Thermal Resistances report, [AN061](#).

Note 6. $\theta_{JA(EVB)}$, $\Psi_{JC(TOP)}$, and Ψ_{JB} are measured on a high effective-thermal-conductivity four-layer test board which is in size of 70mm x 50mm; furthermore, all layers with 1 oz. Cu. Thermal resistance/parameter values may vary depending on the PCB material, layout, and test environmental conditions.

14 Electrical Characteristics

($V_{EN} = 1.1V$, $V_{IN} = V_{OUT} + 0.3V$, $V_{BIAS} = 5V$, $C_{BIAS} = 0.1\mu F$, $C_{IN} = C_{OUT} = 10\mu F$, $C_{SS} = 1nF$, $I_{OUT} = 50mA$, $T_J = -40^{\circ}C$ to $125^{\circ}C$, otherwise specified. Typical values are at $T_A = 25^{\circ}C$.)

Parameter	Symbol	Test Conditions	Min	Typ	Max	Unit
Input Voltage	V_{IN}		$V_{OUT} + V_{DROP}$	--	5.5	V
VBIAS Pin Voltage	V_{BIAS}		2.7	--	5.5	V
Reference Voltage	V_{REF}	$T_A = 25^{\circ}C$	0.796	0.8	0.804	V
Output Voltage Range	V_{OUT}	$V_{IN} = 5V$, $I_{OUT} = 1A$	V_{REF}	--	3.6	V
Output Voltage Accuracy	V_{OUT_ACC}	$2.97V \leq V_{BIAS} \leq 5.5V$, $50mA \leq I_{OUT} \leq 1A$	-1	± 0.5	1	%
Line Regulation	V_{LINE_REG}	$V_{OUT} (Normal) + 0.3 \leq V_{IN} \leq 5.5V$	--	0.03	--	%/V
Load regulation	V_{LOAD_REG}	$50mA \leq I_{OUT} \leq 1A$	--	0.09	--	%/A
V_{IN} Dropout Voltage	V_{VIN_DROP}	$I_{OUT} = 1A$, $V_{BIAS} - V_{OUT} (Normal) \geq 3.25V$	--	50	80	mV
VBIAS Dropout Voltage	V_{VBIAS_DROP}	$I_{OUT} = 1A$, $V_{IN} = V_{BIAS}$	--	--	1.2	V
		$I_{OUT} = 0.5A$, $V_{IN} = V_{BIAS}$	--	--	1.1	V
Current Limit	I_{LIM}	$V_{OUT} = 80\% \times V_{OUT} (Normal)$	--	1.6	--	A
Bias Pin Current	I_{BIAS}		--	1	2	mA
Shutdown Supply Current (I_{GND})	I_{SHDN}	$V_{EN} = 0.4V$	--	1	50	μA
Feedback Pin Current	I_{FB}		-1	0.15	1	μA
Power-Supply Rejection (V_{IN} to V_{OUT})	PSRR (Note 7)	1kHz, $I_{OUT} = 0.5A$, $V_{IN} = 1.8V$, $V_{OUT} = 1.5V$	--	75	--	dB
		300kHz, $I_{OUT} = 0.5A$, $V_{IN} = 1.8V$, $V_{OUT} = 1.5V$	--	30	--	
Power-Supply Rejection (V_{BIAS} to V_{OUT})	PSRR (Note 7)	1kHz, $I_{OUT} = 0.5A$, $V_{IN} = 1.8V$, $V_{OUT} = 1.5V$	--	90	--	dB
		300kHz, $I_{OUT} = 0.5A$, $V_{IN} = 1.8V$, $V_{OUT} = 1.5V$	--	40	--	
Output Noise Voltage	V_n (Note 7)	100Hz to 100kHz, $I_{OUT} = 0.5A$, $C_{SS} = 1nF$	--	$25 \times V_{OUT}$	--	μV_{RMS}
Minimum Startup Time	t_{STR} (Note 7)	R_{LOAD} for $I_{OUT} = 1A$, $C_{SS} = open$	--	200	--	μs
Soft-Start Charging Current	I_{SS}	$V_{SS} = 0.4V$	--	440	--	nA
EN Input Voltage Rising Threshold	V_{EN_R}		1.1	--	5.5	V
EN Input Voltage Falling Threshold	V_{EN_F}		0	--	0.4	V
EN Pin Hysteresis	V_{EN_HYS}		--	50	--	mV
EN Pin Deglitch Time	V_{EN_DG}		--	20	--	μs
EN Pin Current	I_{EN}	$V_{EN} = 5V$	--	0.1	1	μA
Power-Good Voltage Threshold	V_{PG}	V_{OUT} decreasing	86	91	95	% V_{OUT}

Parameter	Symbol	Test Conditions	Min	Typ	Max	Unit
Power-Good Voltage Hysteresis	V _{PG_HYS}		--	3	--	%V _{OUT}
Power-Good Output Low Voltage	V _{PG_L}	I _{PG} = 1mA(sinking), V _{OUT} < V _{PG}	--	--	0.3	V
Power-Good Leakage Current	V _{PG_LK}	V _{PG} = 5.25V, V _{OUT} > V _{PG}	--	0.1	1	μA
Over-Temperature Protection Threshold	T _{OTP}	Shutdown, temperature increasing	--	165	--	°C
		Reset, temperature decreasing	--	140	--	
Discharge Resistor	R _{DISCHG}	V _{EN} ≤ 0.4V	--	10	--	Ω

Note 7. Guaranteed by design.

15 Typical Application Circuit

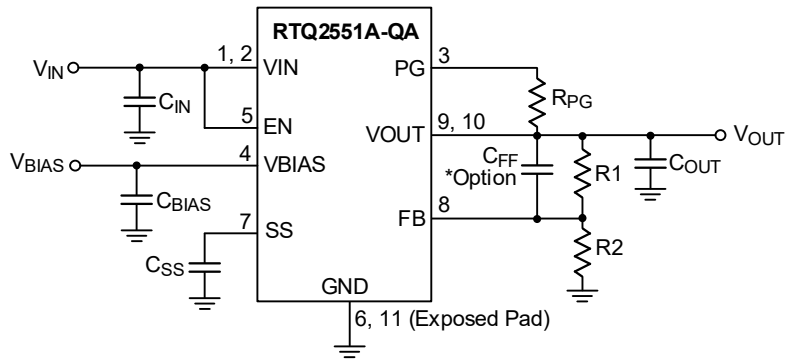

*: The feedforward capacitor is optional for the transient response and circuit stability improvement.

Table 1. Suggested Component Value

Vout(V)	R1(kΩ)	R2(kΩ)
0.8	Short	Open
0.9	0.619	4.99
1.0	1.13	4.52
1.05	1.37	4.42
1.1	1.87	4.99
1.2	2.49	4.99
1.5	4.12	4.75
1.8	3.57	2.87
2.5	3.57	1.69
3.3	3.57	1.15

Table 2.. Recommended External Components

Component	Description	Vendor P/N
C _{IN} , C _{OUT} (Note 8)	10μF, 16V, X7S, 0805	GCM21BC71C106KE36 (Murata)
C _{SS}	1nF, 50V, X7R, 0603	GCD188R71H102KA01 (Murata)
C _{BIAS}	0.1μF, 50V, X7R, 0603	GCJ188R71H104KA12 (Murata)

Note 8. Considering the effective capacitance derated with biased voltage level, the C_{OUT} component needs satisfy the effective capacitance at least 2.2μF or above at targeted output level for stable and normal operation.

16 Typical Operating Characteristics

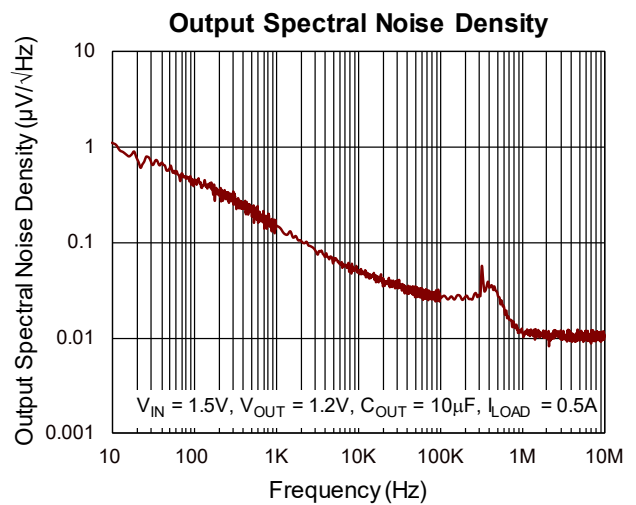
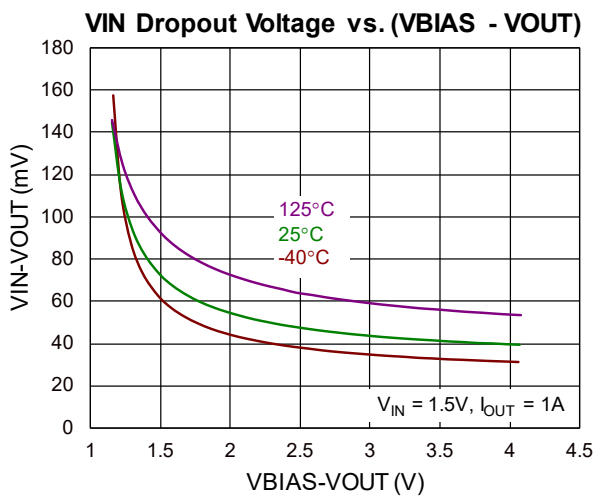
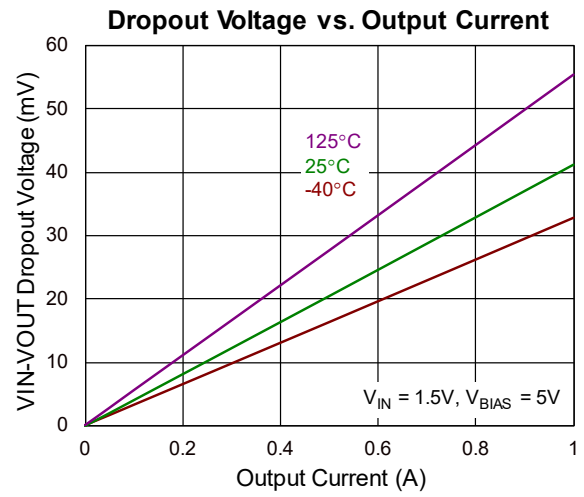
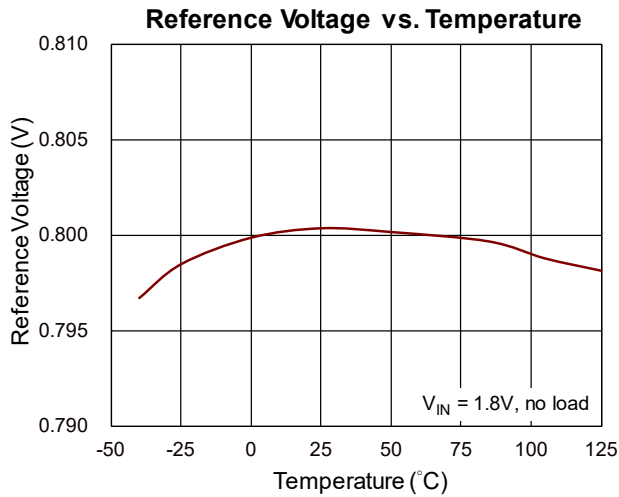
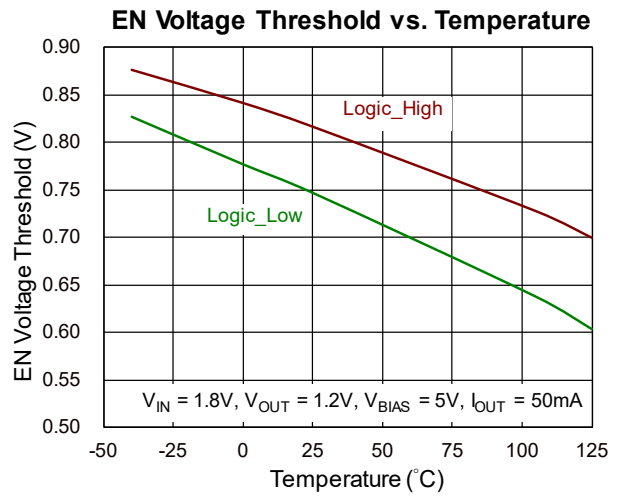
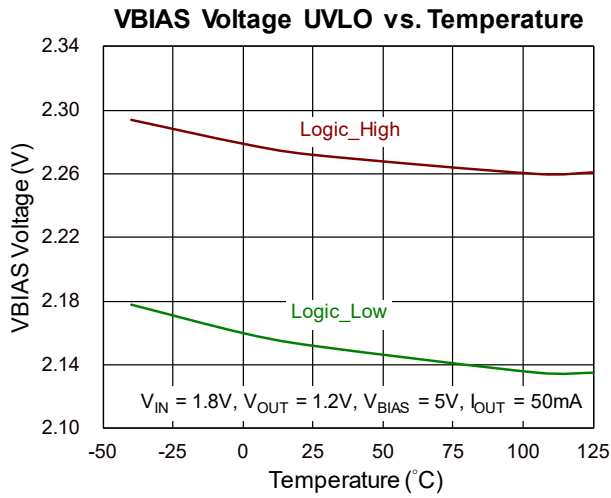

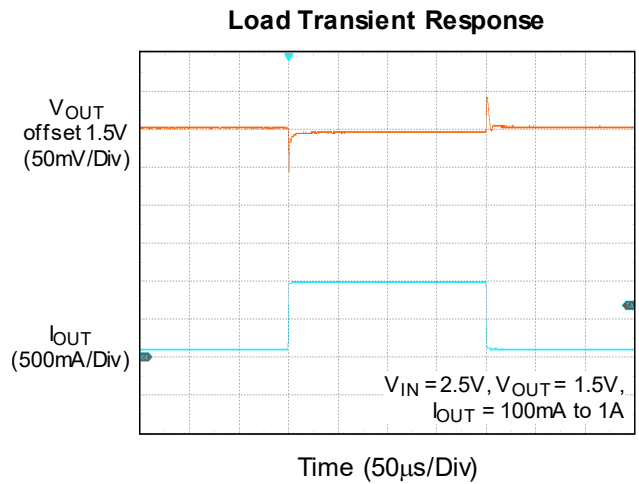
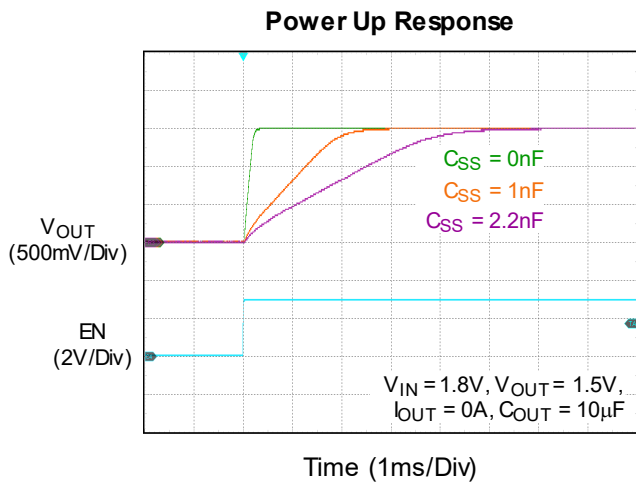
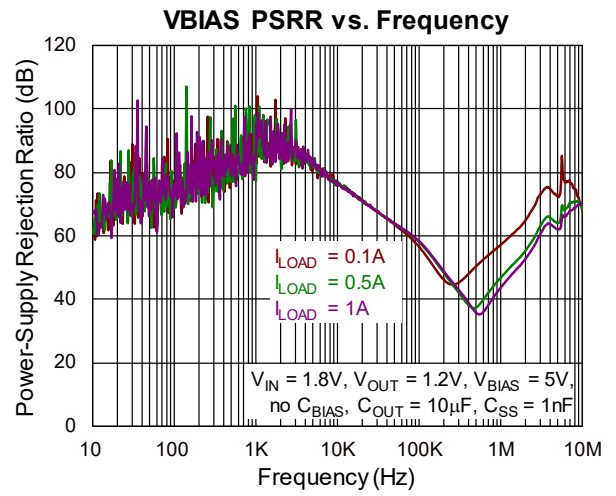
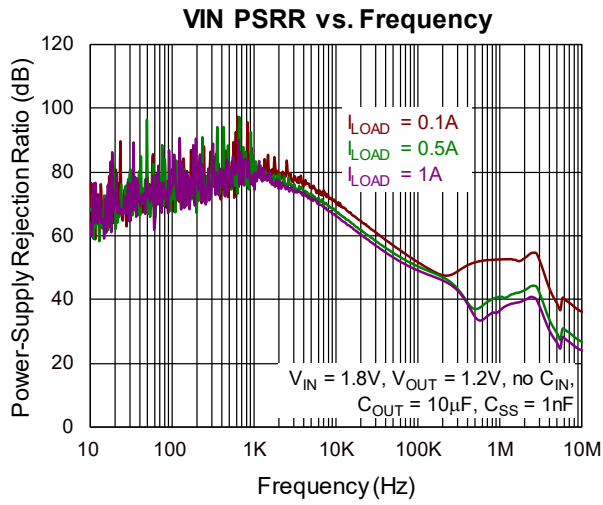

17 Operation

The RTQ2551A-QA is a very low dropout linear regulator that operates from an input voltage as low as 0.8V. It provides a highly accurate output that is capable of supplying 1A of output current with a typical dropout voltage of only 50mV. The output voltage range is from 0.8V to 3.6V.

17.1 VIN and VBIAS Supply

The VBIAS input supplies the internal reference and LDO circuitry while all output current comes directly from the VIN input for high-efficiency regulation. With an external VBIAS 3.25V above VOUT, the RTQ2551A-QA offers very low dropout performance, which allows the device to be used in place of a DC-DC converter and still achieves good efficiency. This provides designers to achieve the smallest, simplest, and lowest-cost solution.

For applications where an auxiliary bias voltage is not available or low dropout is not required. In these applications, VBIAS is suggested to be 1.2V above VOUT and attention to power rating and thermal management is needed.

17.2 Enable and Shutdown

The EN pin is active high. Applying a voltage above 1.1V ensures the LDO regulator turns on, while the regulator turns off if the VEN falls below 0.4V. The enable circuitry has a typical 50mV hysteresis and deglitching for use with relatively slowly ramping analog signals. That helps avoid on-off cycling as a result of small glitches in the VEN signal. A fast rise-time signal must be used to enable the RTQ2551A-QA if precise turn-on timing is required. If not used, EN can be connected to either the VIN or VBIAS pins. If EN is connected to the VIN pin, it should be connected as close as possible to the largest capacitance on the input to prevent voltage droops on that line from triggering the enable circuit.

17.3 Output Active Discharge

When the RTQ2551AN-QABB operates at shutdown mode, the device has an internal active pull-down circuit that connects the output to GND through a 10Ω resistor for output discharge purpose.

17.4 Soft-Start

The RTQ2551A-QA includes a soft-start feature to prevent excessive current flow during start-up. When the LDO is enabled, an internal soft-start current (ISS) charges the external soft-start capacitor (CSS) to build a ramp-up voltage internally. The RTQ2551A-QA achieves a linear and monotonic soft-start by tracking the voltage ramp until the voltage exceeds the internal reference. The soft-start ramp time can be calculated using the following equation:

$$t_{SS}(\text{ms}) = \frac{V_{REF} \times C_{SS}}{I_{SS}} = \frac{0.8\text{V} \times C_{SS}(\text{nF})}{0.44\mu\text{A}}$$

17.5 Power-Good Indicator

When the output voltage is greater than VPG + VPG_HYS, the output voltage is considered good, and the open-drain PG pin goes high impedance and is typically pulled high with an external resistor. If VOUT drops below VPG or if VBIAS drops below 1.9 V, the open-drain output turns on and pulls the PG output low. The PG pin also asserts when the device is disabled, or when OCP or OTP is triggered.

17.6 Overcurrent Protection

The RTQ2551A-QA has built-in overcurrent protection. When overcurrent (typically 1.6A) is detected, the RTQ2551A-QA foldbacks and limits the current at typically 1.2A. It allows the device to supply surges of up to 1.6A and prevents the device overheating if a short circuit occurs.

17.7 Over-Temperature Protection

The RTQ2551A-QA includes an over-temperature protection (OTP) circuitry to prevent overheating due to excessive power dissipation. The LDO will shut down when the junction temperature exceeds approximately 165°C. It will re-enable the LDO once the junction temperature drops back to approximately 140°C. The RTQ2551A-QA will cycle in and out of thermal shutdown without latch-up or damage until the overstress condition is removed. Long-term overstress ($T_J > 125^\circ\text{C}$) should be avoided as it can degrade the performance or shorten the life of the part.

Note that the over-temperature protection is intended to protect the device during momentary overload conditions. The protection is activated outside the absolute maximum range of operation as a secondary fail-safe and therefore should not be relied upon operationally. Continuous operation above the specified absolute maximum operating junction temperature may impair device reliability or permanently damage the device.

18 Application Information

([Note 9](#))

The RTQ2551A-QA is a low dropout regulator that features soft-start capability. It provides EN and PG for easily system sequence control, and built-in overcurrent and over-temperature protection for safe operation.

18.1 Dropout Voltage

Because of two power supply inputs, VIN and VBIAS, and one VOUT regulator output, there are two specified dropout voltages. The first is the VIN dropout voltage, which is the voltage difference (VIN – VOUT) when VOUT starts to decrease by percentage specified in the [Electrical Characteristics](#) table.

The second is the VBIAS dropout voltage, which is the voltage difference (VBIAS – VOUT) when the VIN and VBIAS pins are joined together and VOUT starts to decrease. This option allows the device to be used in applications where an auxiliary bias voltage is not available or low dropout is not required. In these applications, VBIAS is suggested to be 1.2V above VOUT and attention to power rating and thermal considerations is needed.

18.2 Input, Output, and Bias Capacitor Selection

The device is designed to be stable for all available types and values of output capacitors $\geq 2.2\mu\text{F}$. The device is also stable with multiple capacitors in parallel, which can be of any type or value. The capacitance required on the VIN and VBIAS pins strongly depends on the input supply source impedance. To counteract any inductance in the input, the minimum recommended capacitor for VIN is $1\mu\text{F}$ and the minimum recommended capacitor for VBIAS is $0.1\mu\text{F}$. If the VIN and VBIAS pins are connected to the same supply, the recommended minimum capacitor for VBIAS is $4.7\mu\text{F}$. Good quality, low ESR capacitors should be used on the input; ceramic X5R and X7R capacitors are preferred. These capacitors should be placed as close to the pins as possible for optimum performance.

18.3 Adjustable Output Voltage

The output voltage of the RTQ2551A-QA is adjustable from 0.8V to 3.6V using external voltage divider resistors, as shown in [Typical Application Circuit](#). R1 and R2 can be calculated to set the desired output voltage. To achieve the maximum accuracy specifications, R2 should be $\leq 4.99\text{k}\Omega$.

18.4 Power Up Sequence Requirement

The RTQ2551A-QA supports powering on the input VIN, VBIAS, and EN pins in any order without damaging the device. Generally, connecting the EN and VIN pins for most applications is acceptable, as long as VIN and VEN are greater than the EN threshold (typically 1.1V) and the input ramp rate of VIN and VBIAS is faster than the output settled soft-start ramp rate. If the VIN/VBIAS input source ramp rate is slower than the output settled soft-start time, the output will track the input supply rampup level minus the dropout voltage until it reaches the settled output voltage level. For the other case, if EN is connected with the VBIAS pin, and the provided VIN is present before VBIAS, the output soft-start will proceed as programmed. While VBIAS and VEN are present before VIN is applied and the settled soft-start time has expired, then VOUT tracks the VIN ramp-up. If the soft-start time has not expired, the output tracks the VIN ramp-up until the output reaches the value set by the charging soft-start capacitor.

18.5 Thermal Consideration

The junction temperature should never exceed the absolute maximum junction temperature $T_{J(MAX)}$, listed under Absolute Maximum Ratings, to avoid permanent damage to the device. The maximum allowable power dissipation depends on the thermal resistance of the IC package, the PCB layout, the rate of surrounding airflow, and the difference between the junction and ambient temperatures. The maximum power dissipation can be calculated using the following formula:

$$P_{D(MAX)} = (T_{J(MAX)} - T_A) / \theta_{JA}$$

where $T_{J(MAX)}$ is the maximum junction temperature, T_A is the ambient temperature, and θ_{JA} is the junction-to-ambient thermal resistance.

For continuous operation, the maximum operating junction temperature indicated under Recommended Operating Conditions is 125°C. The junction-to-ambient thermal resistance, $\theta_{JA(EVB)}$, is highly package dependent. For a WDFN-10L 3x3 package, the thermal resistance, $\theta_{JA(EVB)}$, is 41.5°C/W on a high effective-thermal-conductivity four-layer test board. The maximum power dissipation at $T_A = 25^\circ\text{C}$ can be calculated as below:

$$P_{D(MAX)} = (125^\circ\text{C} - 25^\circ\text{C}) / (41.5^\circ\text{C/W}) = 2.41\text{W for a WDFN-10L 3x3 package.}$$

The maximum power dissipation depends on the operating ambient temperature for the fixed $T_{J(MAX)}$ and the thermal resistance, $\theta_{JA(EVB)}$. The derating curve in [Figure 1](#) allows the designer to see the effect of rising ambient temperature on the maximum power dissipation.

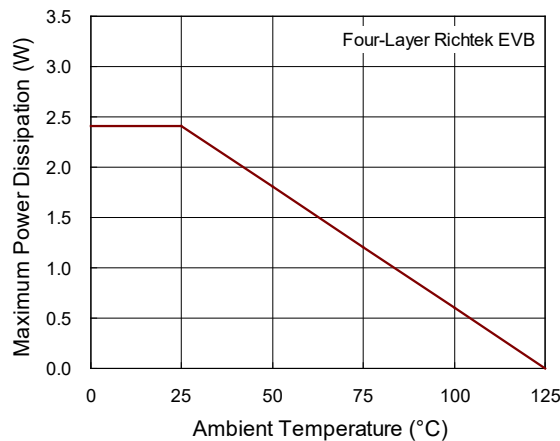

Figure 1. Derating Curve of Maximum Power Dissipation

18.6 Layout Considerations

For best performance of the RTQ2551A-QA, the following PCB layout suggestions are highly recommended:

- The input capacitor must be placed as close as possible to the IC to minimize the power loop area.
- Minimize the power trace length and avoid using vias for the input and output capacitors connection.

[Figure 2](#) shows an example for the layout reference that helps minimize inductive parasitic components, reduce load transients, and ensure good circuit stability.

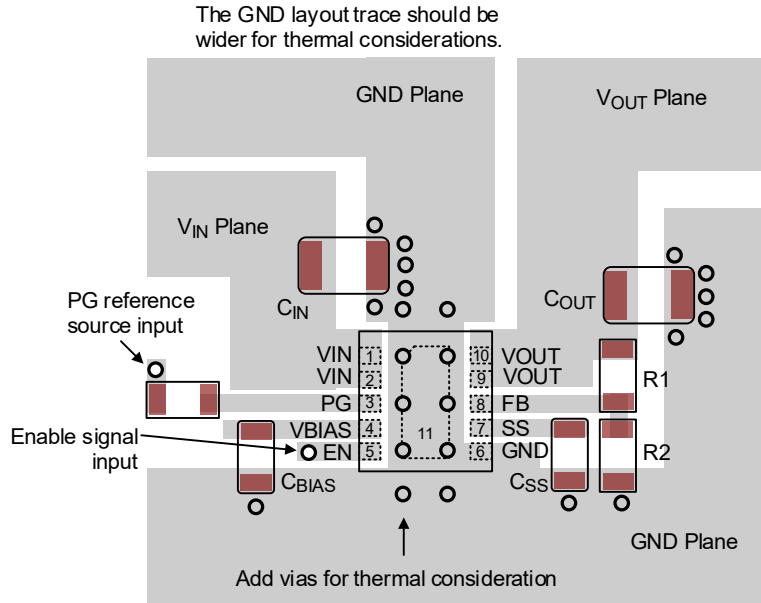
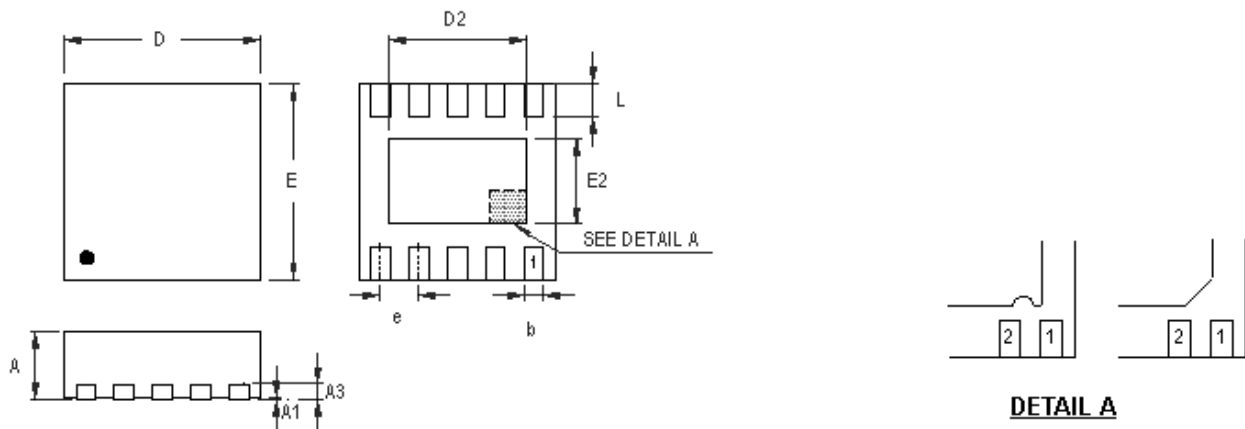

Figure 2. PCB Layout Guide

Note 9. The information provided in this section is for reference only. The customer is solely responsible for the designing, validating, and testing your product incorporating Richtek’s product and ensure such product meets applicable standards and any safety, security, or other requirements.

19 Outline Dimension



DETAIL A
Pin #1 ID and Tie Bar Mark Options

Note : The configuration of the Pin #1 identifier is optional, but must be located within the zone indicated.

Symbol	Dimensions In Millimeters		Dimensions In Inches	
	Min	Max	Min	Max
A	0.700	0.800	0.028	0.031
A1	0.000	0.050	0.000	0.002
A3	0.175	0.250	0.007	0.010
b	0.180	0.300	0.007	0.012
D	2.950	3.050	0.116	0.120
D2	2.300	2.650	0.091	0.104
E	2.950	3.050	0.116	0.120
E2	1.500	1.750	0.059	0.069
e	0.500		0.020	
L	0.350	0.450	0.014	0.018

W-Type 10L DFN 3x3 Package

20 Footprint Information

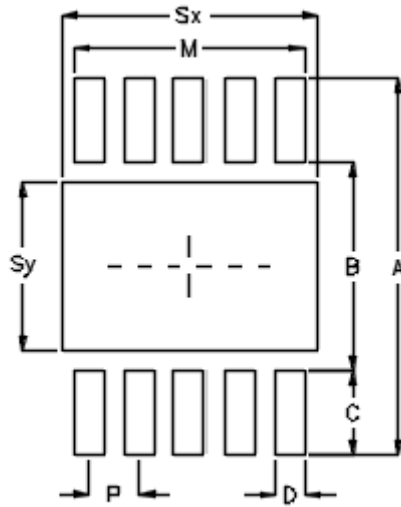

Package	Number of Pin	Footprint Dimension (mm)								Tolerance
		P	A	B	C	D	Sx	Sy	M	
V/W/U/X/ZDFN3*3-10	10	0.50	3.80	2.10	0.85	0.30	2.55	1.70	2.30	±0.05

21 Packing Information

21.1 Tape and Reel Data

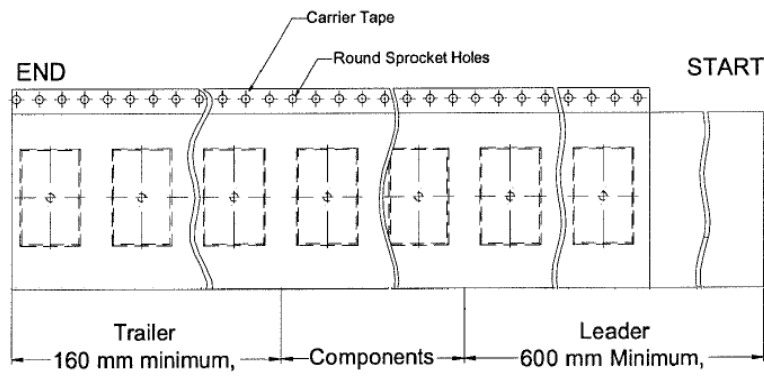
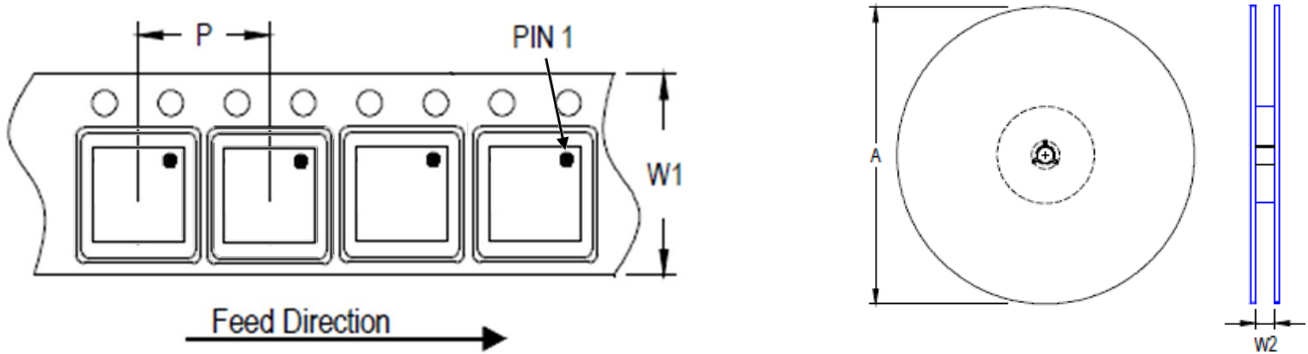

Package Type	Tape Size (W1) (mm)	Pocket Pitch (P) (mm)	Reel Size (A)		Units per Reel	Trailer (mm)	Leader (mm)	Reel Width (W2) Min./Max. (mm)
			(mm)	(in)				
QFN/DFN 3x3	12	8	180	7	1,500	160	600	12.4/14.4

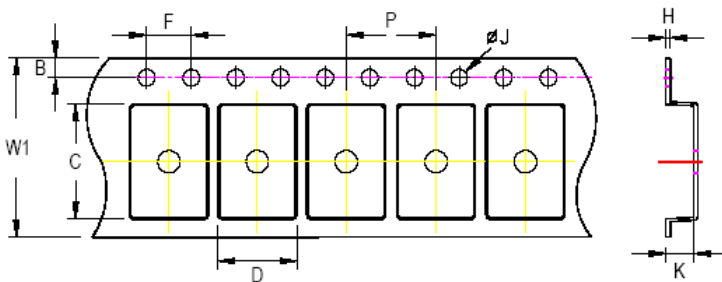







C, D, and K are determined by component size. The clearance between the components and the cavity is as follows:

- For 12mm carrier tape: 0.5mm max.

Tape Size	W1		P		B		F		ØJ		H
	Max	Min	Max	Min	Max	Min	Max	Min	Max	Max	
12mm	12.3mm	7.9mm	8.1mm	1.65mm	1.85mm	3.9mm	4.1mm	1.5mm	1.6mm	0.6mm	

21.2 Tape and Reel Packing

Step	Photo/Description	Step	Photo/Description
1	 <p>Reel 7"</p>	4	 <p>3 reels per inner box Box A</p>
2	 <p>HIC & Desiccant (1 Unit) inside</p>	5	 <p>12 inner boxes per outer box</p>
3	 <p>Caution label is on backside of Al bag</p>	6	 <p>Outer box Carton A</p>

Package	Reel		Box			Carton		
	Size	Units	Item	Reels	Units	Item	Boxes	Unit
QFN/DFN 3x3	7"	1,500	Box A	3	4,500	Carton A	12	54,000
			Box E	1	1,500	For Combined or Partial Reel.		

21.3 Packing Material Anti-ESD Property

Surface Resistance	Aluminum Bag	Reel	Cover tape	Carrier tape	Tube	Protection Band
Ω/cm^2	10^4 to 10^{11}	10^4 to 10^{11}	10^4 to 10^{11}	10^4 to 10^{11}	10^4 to 10^{11}	10^4 to 10^{11}

Richtek Technology Corporation

14F, No. 8, Tai Yuen 1st Street, Chupei City

Hsinchu, Taiwan, R.O.C.

Tel: (8863)5526789



Richtek products are sold by description only. Richtek reserves the right to change the circuitry and/or specifications without notice at any time. Customers should obtain the latest relevant information and data sheets before placing orders and should verify that such information is current and complete. Richtek cannot assume responsibility for use of any circuitry other than circuitry entirely embodied in a Richtek product. Information furnished by Richtek is believed to be accurate and reliable. However, no responsibility is assumed by Richtek or its subsidiaries for its use; nor for any infringements of patents or other rights of third parties which may result from its use. No license is granted by implication or otherwise under any patent or patent rights of Richtek or its subsidiaries.

Copyright © 2024 Richtek Technology Corporation. All rights reserved.  is a registered trademark of Richtek Technology Corporation.

www.richtek.com

RTQ2551A-QA_DS-01 September 2024

22 Datasheet Revision History

Version	Date	Description	Item
00	2024/1/8	Final	<i>Features on page 1 General Description on page 1 Recommended Operating Conditions on page 6 Electrical Characteristics on page 7</i>
01	2024/9/26	Modify	<i>Changed the names of pin 3 to PG Ordering Information on page 2 - Added RTQ2551AN-QABB Marking Information on page 2 - Added RTQ2551AN-QABB Electrical Characteristics on page 6, 7 Operation on page 11 Application Information on page 13, 15</i>