

## Smart Power-Management Integrated Circuit for Camera Module Application

### General Description

The RT5112H device is a smart power management IC which includes a low-quiescent-current HCOT Buck converter, a ACOT Boost converter and four high PSRR low dropout regulators (LDO). One can control the channel power sequence, output voltage level and DVS slew rate by setting registers via I<sup>2</sup>C interface. The output voltage OVP/UVP, OCP and OTP protection are built in the RT5112H. The RT5112H is available in a WL-CSP-25B 2.2x2.3 (BSC) package.

### Applications

- Camera Module
- Optical Module
- SSD

### Ordering Information

RT5112H□

Package Type

WSC : WL-CSP-25B 2.2x2.3 (BSC)

Note :

Richtek products are :

- ▶ RoHS compliant and compatible with the current requirements of IPC/JEDEC J-STD-020.
- ▶ Suitable for use in SnPb or Pb-free soldering processes.

### Features

#### System Control

- Hardware Enable Pin
- I<sup>2</sup>C Controlled Interface
- Programmable Channel Power Sequence
- IRQ Output for Indication
- Over-Voltage Protection
- Under-Voltage Protection
- Over-Current Protection
- Over-Temperature Protection
- Available in a WL-CSP-25B 2.2x2.3 (BSC) Package

#### High Efficiency Buck Converter

- Wide 2.5V to 5.5V Operating Input Range
- Programmable Output Voltage from 0.6V to 3.3V with 12.5mV/Step
- Maximum Continuous Load Current : 1.2A
- HCOT Control Operation
- Low Quiescent Current

#### Flexible Boost Converter

- Wide 2.5V to 4.4V Operating Input Range
- Programmable Output Voltage from 4.5 V to 5.5V with 25mV/Step
- Maximum Continuous Load Current : 1A
- ACOT Control Operation
- Low Quiescent Current

#### Four Low Dropout Regulators

- Wide 1.9V to 5.5V Operating Input Range
- Programmable Output Voltage from 0.6V to 3.775V with 25mV/Step
- High PSRR : 70dB @ 1kHz, 40dB @ 100kHz with LDO1 / LDO2
- High PSRR : 50dB @ 1kHz, 40dB @ 10kHz with LDO3 / LDO4
- 300mA Low Dropout Voltage Regulators
- Low Quiescent Current

## Marking Information

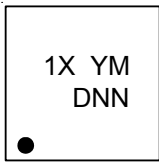

1X : Product Code  
 YMDNN : Date Code

## Pin Configuration

(TOP VIEW)

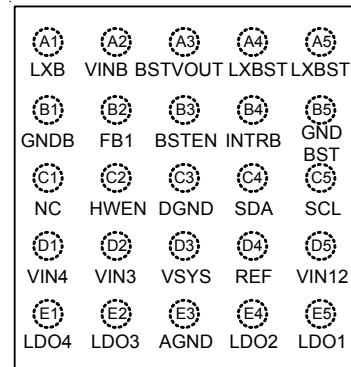

WL-CSP-25B 2.2 x 2.3 (BSC)

## Typical Application Circuit

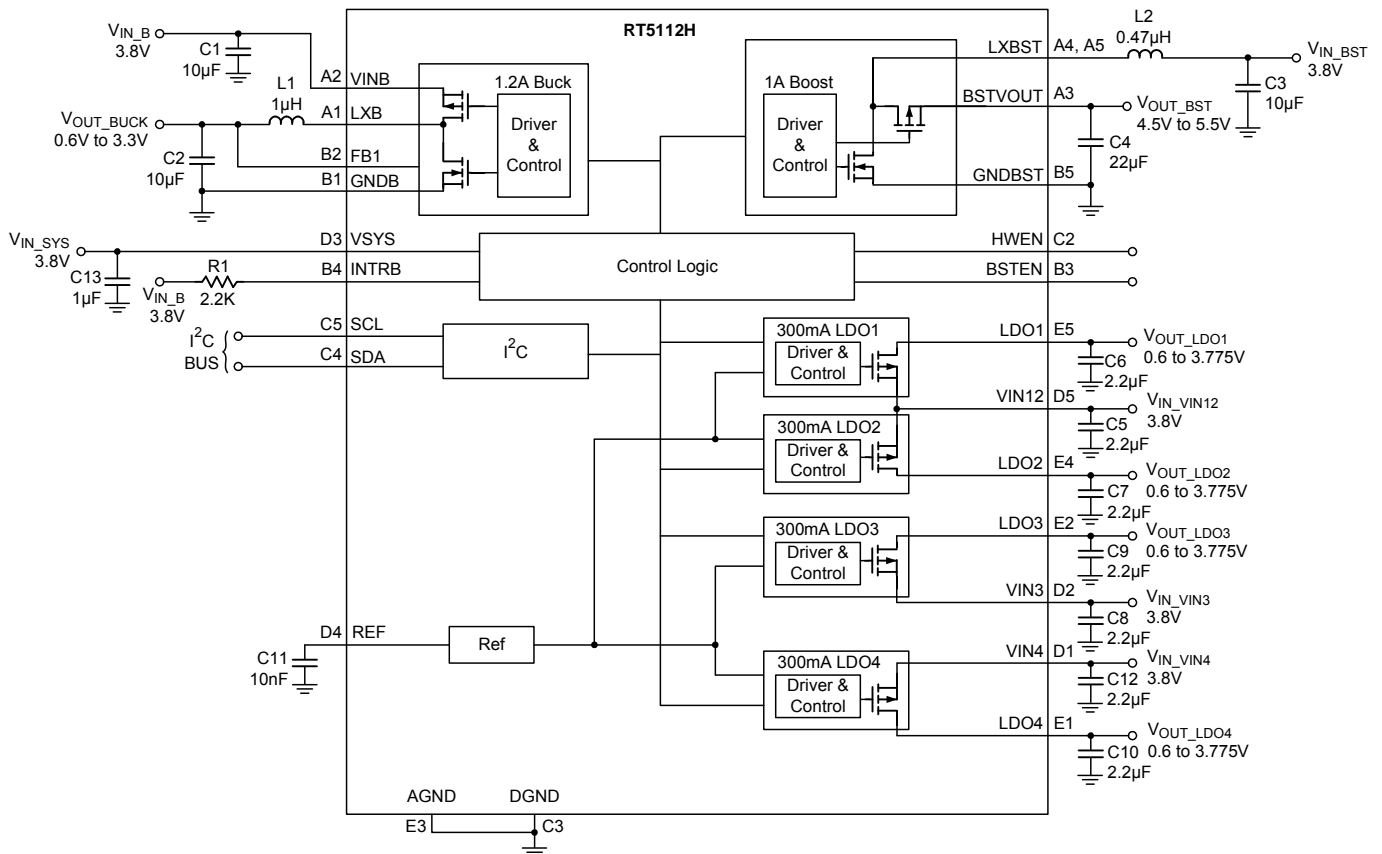

Component List of Evaluation Board

Reference	Qty	Part Number	Description	Package	Manufacturer
C1, C2, C3	1	JMK105CBBJ106MV-F	10 $\mu$ F/X5R/6.3V	0402	TAIYO YUDEN
C4	1	JMK107BBJ226MA-T	22 $\mu$ F/X5R/6.3V	0603	TAIYO YUDEN
C5, C8, C12	1	JMK105BJ225KV-F	2.2 $\mu$ F/X5R/6.3V	0402	TAIYO YUDEN
C6, C7, C9, C10	1	GRM033R60J225ME47D	2.2 $\mu$ F/X5R/6.3V	0201	MURATA
C11	1	LMK105BJ103KV-F	10nF/X5R/6.3V	0402	TAIYO YUDEN
C13	1	LMK063BBJ105MPLF	1 $\mu$ F/X5R/10V	0201	TAIYO YUDEN
L1	1	MEKK2016T1R0M	1 $\mu$ H/3.1A/50m $\Omega$	2016	TAIYO YUDEN
L2	1	DFE201210S-R47MH=P2	0.47 $\mu$ H/3.4A/32m $\Omega$	2012	MURATA

## Functional Pin Description

Pin No.	Pin Name	Pin Function
A1	LXB	Buck switch output. Connect this pin to an inductor with a wide PCB trace.
A2	VINB	Supply voltage input of Buck. The IC operates from a 2.5V to 5.5V input rail. It requires a 10 $\mu$ F decouple ceramic capacitor. Connect this pin to input voltage with a wide PCB trace.
A3	BSTVOUT	Boost output pin. PCB trace length from BSTVOUT to the output filter capacitor should be as short and wide as possible. It requires a 22 $\mu$ F decouple ceramic capacitor. BSTVOUT is completely disconnected from LXBST when Boost is at off state.
A4, A5	LXBST	Boost switch output. Connect this pin to an inductor with a wide PCB trace and keep the PCB trace length as short and wide as possible to reduce EMI and voltage spike.
B1	GNDB	Buck power ground.
B2	FB1	Feedback of Buck. Directly connect the Buck's output to this pin.
B3	BSTEN	Boost enable control input.
B4	INTRB	Interrupt output. Open drain output. When interrupt happens, interrupt pin is pulled down.
B5	GNDBST	Boost power ground.
C1	NC	NC internal connection and should keep floating state.
C2	HWEN	Chip enable control input.
C3	DGND	Digital ground.
C4	SDA	I <sup>2</sup> C data pin.
C5	SCL	I <sup>2</sup> C clock signal input.
D1	VIN4	LDO4 power supply input. It requires a 2.2 $\mu$ F decouple ceramic capacitor.
D2	VIN3	LDO3 power supply input. It requires a 2.2 $\mu$ F decouple ceramic capacitor.
D3	VSYS	System analog power supply. It requires a 1 $\mu$ F decouple ceramic capacitor. It also connected to V <sub>INB</sub> externally.

Pin No.	Pin Name	Pin Function
D4	REF	Internal reference output. It requires a 10nF decouple ceramic capacitor.
D5	VIN12	LDO1 and 2 power supply input. It requires a 2.2μF decouple ceramic capacitor.
E1	LDO4	LDO4 output. It requires a 2.2μF decouple ceramic capacitor.
E2	LDO3	LDO3 output. It requires a 2.2μF decouple ceramic capacitor.
E3	AGND	Analog ground.
E4	LDO2	LDO2 output. It requires a 2.2μF decouple ceramic capacitor.
E5	LDO1	LDO1 output. It requires a 2.2μF decouple ceramic capacitor.

Functional Block Diagram

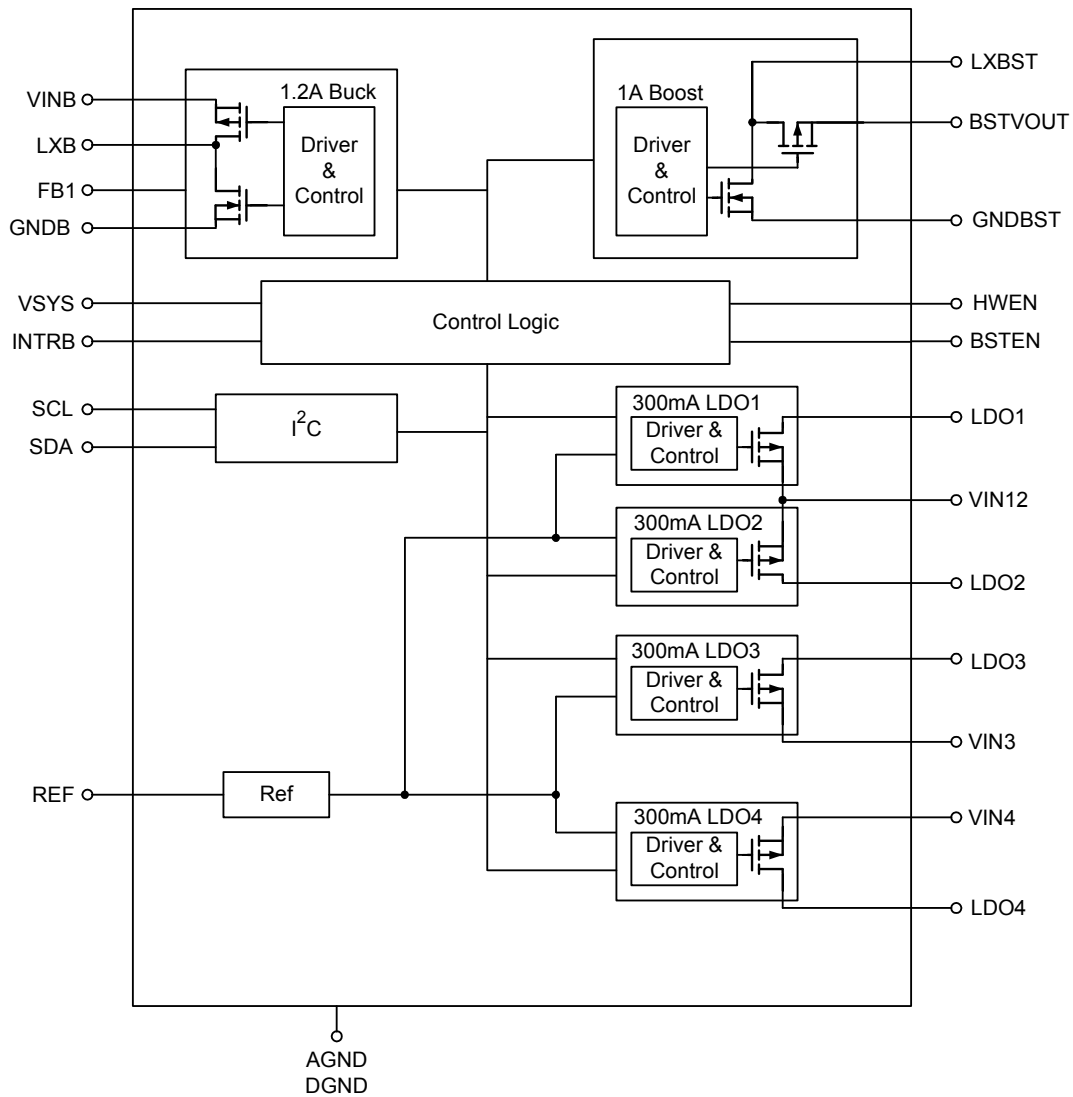

**Absolute Maximum Ratings** (Note 1)

- VSYS, VINB, VIN12, VIN3, VIN4, BSTVOUT, LDO1, LDO2, LDO3, LDO4, FB1, REF, SCL, SDA, HWEN, BSTEN, INTRB, LXB, LXBST ----- -0.3V to 6.5V
- LXB, LXBST (< 20ns) ----- -2V to 9V
- Power Dissipation, P<sub>D</sub> @ T<sub>A</sub> = 25°C  
 WL-CSP-25B 2.2x2.3 (BSC) ----- 3.05W
- Package Thermal Resistance (Note 2)  
 WL-CSP-25B 2.2x2.3 (BSC), θ<sub>JA</sub> ----- 32.7°C/W
- Junction Temperature ----- 150°C
- Lead Temperature (Soldering, 10 sec.) ----- 260°C
- Storage Temperature Range ----- -65°C to 150°C
- Reflow Number of Times ----- ≤ 5
- ESD Susceptibility (Note 3)  
 HBM (Human Body Mode) ----- 2kV

**Recommended Operating Conditions** (Note 4)

- Supply Voltage V<sub>IN\_B</sub>, V<sub>SYN</sub> ----- 2.5V to 5.5V
- Supply Voltage V<sub>IN\_BST</sub> ----- 2.5V to V<sub>OUT\_BST</sub> - 0.1V
- Supply Voltage V<sub>IN\_VIN12</sub>, V<sub>IN\_VIN3</sub>, V<sub>IN\_VIN4</sub> ----- 1.9V to 5.5V
- Junction Temperature Range ----- -40°C to 125°C
- Ambient Temperature Range ----- -40°C to 85°C

**Electrical Characteristics**

(T<sub>A</sub> = 25°C, unless otherwise specified.)

Parameter	Symbol	Test Conditions	Min	Typ	Max	Unit
<b>System Parameter</b>						
Quiescent Current	I <sub>QTATOL</sub>	HWEN = BSTEN = H, V <sub>IN_SYS</sub> = V <sub>IN_B</sub> = V <sub>IN_BST</sub> = V <sub>IN_VIN12</sub> = V <sub>IN_VIN3</sub> = V <sub>IN_VIN4</sub> = 3.8V, LDO/Buck/Boost on, no load, automode -40°C to 85°C	--	106	138	μA
	I <sub>QLDO</sub>	HWEN = H, V <sub>IN_SYS</sub> = V <sub>IN_VIN12</sub> = V <sub>IN_VIN3</sub> = V <sub>IN_VIN4</sub> = 3.8V, LDO on, no load, automode	--	95	118	
	I <sub>QBASE</sub>	HWEN = H, V <sub>IN_SYS</sub> = V <sub>IN_B</sub> = 3.8V, all power regulators are off	--	7	10	
	I <sub>QBOOST</sub>	HWEN = L, BSTEN = H, V <sub>IN_SYS</sub> = V <sub>IN_B</sub> = V <sub>IN_BST</sub> = 3.8V, only Boost active, no load, automode	--	12	20	
Leakage Current	I <sub>LEAK</sub>	Leak current, HWEN = BSTEN = L, V <sub>IN_SYS</sub> = V <sub>IN_B</sub> = V <sub>IN_BST</sub> = V <sub>IN_VIN12</sub> = V <sub>IN_VIN3</sub> = V <sub>IN_VIN4</sub> = 2.5V to 5.5V, -40°C to 85°C	--	--	1.5	μA
V <sub>SYN</sub> Under-Voltage Lockout Threshold Rising	UVLO		--	2.35	2.45	V

Parameter	Symbol	Test Conditions	Min	Typ	Max	Unit
Hysteresis Voltage of UVLO	UVLO_H		--	100	--	mV
<b>HWEN and BSTEN Control</b>						
HWEN and BSTEN Low Level Input Voltage	V <sub>IL</sub>		--	--	0.4	V
HWEN and BSTEN High Level Input Voltage	V <sub>IH</sub>		1.2	--	--	V
HWEN and BSTEN Pull Down Resistor	R <sub>EN</sub>		--	1	-	MΩ
<b>Step Down Buck Converter (V<sub>IN_B</sub> = 3.8V, C1 = C2 = 10μF, L1 = 1μH)</b>						
Input Voltage Range	V <sub>IN_B</sub>		2.5	--	5.5	V
Output Voltage Range	V <sub>OUT_BUCK</sub>		0.6	--	3.3	V
Output Voltage Step			--	12.5	--	mV
Output Voltage Accuracy	V <sub>OUT_ACC_BUCK</sub>	All output range of V <sub>OUT_BUCK</sub> , I <sub>OUT</sub> = I <sub>OUT(MAX)</sub>	-2	--	2	%
Switching Frequency	f <sub>SW_BUCK</sub>	V <sub>OUT_BUCK</sub> = 1.1V, operating under CCM	2	2.5	3	MHz
P-Channel MOSFET On Resistance	R <sub>ON_HG_BUCK</sub>	From VINB pin to LXB pin	--	150	200	mΩ
N-Channel MOSFET On Resistance	R <sub>ON_LG_BUCK</sub>	From LXB pin to GNDB pin	--	70	140	mΩ
Maximum Duty Cycle	D <sub>MAX_BUCK</sub>		--	--	100	%
Output Discharge Resistor	R <sub>DIS_BUCK</sub>		80	100	140	Ω
Over-Voltage Rising Threshold Detection	OVP_R_BUCK		--	V <sub>OUT_BUCK</sub> x 120%	--	V
Over-Voltage Falling Threshold Detection	OVP_F_BUCK		--	V <sub>OUT_BUCK</sub> x 109%	--	V
Under-Voltage Rising Threshold Detection	UVP_R_BUCK		--	V <sub>OUT_BUCK</sub> x 92%	--	V
Under-Voltage Falling Threshold Detection	UVP_F_BUCK		--	V <sub>OUT_BUCK</sub> x 80%	--	V
FB1 Leakage Current	I <sub>FB_LK</sub>	Buck disable, 0x0B[7] = 0 (Buck discharge disable), V <sub>IN_B</sub> = 5.5V, V <sub>LXB</sub> = 5.5V, V <sub>FB1</sub> = 5.5V	0	50	100	nA
Switch Leakage Current	I <sub>LXB_LK</sub>	Buck disable, 0x0B[7] = 0 (Buck discharge disable), V <sub>IN_B</sub> = 5.5V, V <sub>LXB</sub> = 0 or 5.5V	0	--	1	μA

Parameter	Symbol	Test Conditions	Min	Typ	Max	Unit
UG Peak Current Limit	$I_{CL\_peak\_BUCK}$	$2.5V \leq V_{IN\_B} \leq 5.5V$	1.5	2	2.5	A
LG Valley Current Limit	$I_{CL\_valley\_BUCK}$	$V_{IN\_B} = 3.6V$	1	1.5	2	A
LG Negative Current Limit	$I_{NCL\_NEG\_BUCK}$	$V_{IN\_B} = 3.6V$ , CCM	0.5	--	3	A
Minimum On Time	$t_{MIN\_ON\_BUCK}$	$V_{IN\_B} = 3.6V$ , $V_{OUT\_BUCK} = 1.8V$	167	200	250	ns
Minimum Off Time	$t_{MIN\_OFF\_BUCK}$	$V_{IN\_B} = V_{OUT\_BUCK} = 3.3V$	20	40	60	ns
<b>Step Up Boost Converter (<math>V_{IN\_BST} = 3.8V</math>, <math>C3 = 10\mu F</math>, <math>C4 = 22\mu F</math>, <math>L2 = 0.47\mu H</math>)</b>						
Input Voltage Range	$V_{IN\_BST}$		2.5	--	4.4	V
Output Voltage Range	$V_{OUT\_BST}$		4.5	5	5.5	V
Output Voltage Step			--	25	--	mV
DC Output Voltage Accuracy	$V_{OUT\_ACC\_BST}$	All output range of $V_{OUT\_BST}$ , $I_{OUT} = I_{OUT(MAX)}$	-2	--	2	%
Switching Frequency	$f_{SW\_BST}$	$V_{OUT\_BST} = 5V$ , operating under CCM	2	3	3.6	MHz
Shutdown Current	$I_{SHDN\_BST}$	HWEN = BSTEN = 0V, from $V_{IN\_BST}$ to GND	--	--	0.5	$\mu A$
Reverse Leakage Current	$I_{LEAK\_BST}$	BSTEN = 0, $V_{OUT\_BST} = 5V$ , from $V_{OUT\_BST}$ to GND, 0x0B[5] = 0	--	--	1.5	$\mu A$
P-Channel MOSFET On Resistance	$R_{ON\_HG\_BST}$	From LXBST pin to BSTOUT pin	--	95	120	m $\Omega$
N-Channel MOSFET On Resistance	$R_{ON\_LG\_BST}$	From LXBST pin to PGND pin	--	100	130	m $\Omega$
Output Discharge Resistor	$R_{DIS\_BST}$		60	100	140	$\Omega$
Over-Voltage Rising Threshold Detection	$OVP\_R\_BST$		--	$V_{OUT\_BST} \times 117\%$	--	V
Over-Voltage Falling Threshold Detection	$OVP\_F\_BST$		--	$V_{OUT\_BST} \times 106\%$	--	V
Under-Voltage Rising Threshold Detection	$UVP\_R\_BST$		--	$V_{OUT\_BST} \times 92.3\%$	--	V
Under-Voltage Falling Threshold Detection	$UVP\_F\_BST$		--	$V_{OUT\_BST} \times 80\%$	--	V
Switch Leakage Current	$I_{LXBST\_LK}$	BSTEN = 0V, $V_{IN\_BST} = V_{LX\_BST} = 5.5V$ , $V_{OUT\_BST} = 0V$	--	100	200	nA
Linear Charge Current Limit	$I_{LC\_BST}$	$V_{IN\_BST} = 2.5$ to $4.4V$ , $V_{OUT\_BST} = 4.5V$ to $5.5V$	--	0.4	--	A
	$I_{LC\_OTW\_BST}$	Over OTW protection 120°C	--	0.1	--	

Parameter	Symbol	Test Conditions	Min	Typ	Max	Unit
Inductor Valley Current Limit	$I_{CL\_valley\_BST}$	$V_{OUT\_BST} = 5V$	2.5	2.8	3.1	A
<b>Low Dropout Voltage Regulator LDO1 and LDO2 (<math>V_{IN\_VIN12} = V_{OUT\_LDO1}/V_{OUT\_LDO2} + 1V</math>, <math>V_{HWEN} = 1.2V</math>, <math>I_{OUT} = 1mA</math>, <math>C_{IN} = 2.2\mu F</math>, <math>C_{OUT} = 2.2\mu F</math>)</b>						
Input Voltage Range	$V_{IN\_VIN12}$		1.9	--	5.5	V
Output Voltage Range	$V_{OUT\_LDO1}/$		0.6	2.8	3.775	V
Output Voltage Step	$V_{OUT\_LDO2}$		--	25	--	mV
Maximum Output Current	$I_{OUT\_LDO1}/$ $I_{OUT\_LDO2}$		300	--	--	mA
Soft-Start Time	$t_{SS\_LDO1}/$ $t_{SS\_LDO2}$	Time from $V_{OUT\_LDO1} /$ $V_{OUT\_LDO2}$ start rising to 90% nominal value, $V_{OUT\_LDO1} /$ $V_{OUT\_LDO2} = 2.8V$ , no load	--	--	150	$\mu s$
DC Output Voltage Accuracy	$V_{OUT\_ACC\_LDO1}/$ $V_{OUT\_ACC\_LDO2}$	All output range of $V_{OUT\_LDO1} /$ $V_{OUT\_LDO2}$ , $I_{OUT} = I_{OUT(MAX)}$	-2	--	2	%
Load Regulation	$V_{LOAD\_REG\_LDO1}/$ $V_{LOAD\_REG\_LDO2}$	$I_{OUT} = 0$ to $I_{OUT(MAX)}$	-0.5	--	0.5	%
Line Regulation	$V_{LINE\_REG\_LDO1}/$ $V_{LINE\_REG\_LDO2}$	$I_{OUT} = 50mA$ to $300mA$ , $V_{IN\_VIN12}$ $= 3.0V$ to $4.4V$ , $V_{OUT\_LDO1} /$ $V_{OUT\_LDO2} = 2.8V$	-0.5	--	0.5	%
Dropout Voltage	$V_{DROP\_LDO1}/$ $V_{DROP\_LDO2}$	$I_{OUT} = 300mA$ , $V_{OUT\_LDO1} /$ $V_{OUT\_LDO2} = 2.8V$ (Note 5)	--	--	250	mV
Output Discharge Resistor	$R_{DIS\_LDO1}/$ $R_{DIS\_LDO2}$		--	10	--	$\Omega$
Over-Voltage Rising Threshold Detection	$OVP\_R\_LDO1/$ $OVP\_R\_LDO2$		--	$V_{OUT\_LDO1}/$ $V_{OUT\_LDO2}$ $\times 120\%$	--	V
Over-Voltage Falling Threshold Detection	$OVP\_F\_LDO1/$ $OVP\_F\_LDO2$		--	$V_{OUT\_LDO1}/$ $V_{OUT\_LDO2}$ $\times 110\%$	--	V
Under-Voltage Rising Threshold Detection	$UVP\_R\_LDO1/$ $UVP\_R\_LDO2$		--	$V_{OUT\_LDO1}/$ $V_{OUT\_LDO2}$ $\times 90\%$	--	V



Parameter	Symbol	Test Conditions	Min	Typ	Max	Unit
Under-Voltage Falling Threshold Detection	UVP_F_LDO1/ UVP_F_LDO2		--	V <sub>OUT_LDO1</sub> / V <sub>OUT_LDO2</sub> x 80%	--	V
Quiescent Current	I <sub>Q_LDO1</sub> /I <sub>Q_LDO2</sub>	HWEN = 1.2V, I <sub>OUT</sub> = 0mA	--	22	27	μA
		HWEN = 0.3V (disable)	--	0.1	1	
Short Circuit Current Limit	I <sub>sc_LDO1</sub> / I <sub>sc_LDO2</sub>		360	--	--	mA
Current Limit	I <sub>Limt_LDO1</sub> / I <sub>Limt_LDO2</sub>	0x01[3:2] = 11 (LDO1 current limit = 360mA), 0x02[3:2] = 11 (LDO2 current limit = 360mA)	360	415	470	mA
Short Protection On Timer	t <sub>scp_ON_LDO1</sub> / t <sub>scp_ON_LDO2</sub>		--	2	--	ms
Short Protection Off Timer	t <sub>scp_OFF_LDO1</sub> / t <sub>scp_OFF_LDO2</sub>		--	40	--	ms
<b>Low Dropout Voltage Regulator LDO3 and LDO4 (V<sub>IN_VIN3</sub>/V<sub>IN_VIN4</sub> = V<sub>OUT_LDO3</sub>/V<sub>OUT_LDO4</sub> + 1V, V<sub>HWEN</sub> = 1.2V, I<sub>OUT</sub> = 1mA, C<sub>IN</sub> = 2.2μF, C<sub>OUT</sub> = 2.2μF)</b>						
Input Voltage Range	V <sub>IN_VIN3</sub> / V <sub>IN_VIN4</sub>		1.9	--	5.5	V
Output Voltage Range	V <sub>OUT_LDO3</sub> / V <sub>OUT_LDO4</sub>		0.6	1.8	3.775	V
Output Voltage Step			--	25	--	mV
Maximum Output Current	I <sub>OUT_LDO3</sub> / I <sub>OUT_LDO4</sub>		300	--	--	mA
Soft-Start Time	t <sub>SS_LDO3</sub> / t <sub>SS_LDO4</sub>	Time from V <sub>OUT_LDO3</sub> / V <sub>OUT_LDO4</sub> start rising to 90% nominal value, V <sub>OUT_LDO3</sub> / V <sub>OUT_LDO4</sub> = 1.8V, no load	--	--	150	μs
DC Output Voltage Accuracy	V <sub>OUT_ACC_LDO3</sub> / V <sub>OUT_ACC_LDO4</sub>	All output range of V <sub>OUT_LDO3</sub> / V <sub>OUT_LDO4</sub> , I <sub>OUT</sub> = I <sub>OUT(MAX)</sub>	-2	--	2	%
Load Regulation	V <sub>LOAD_REG_LDO3</sub> / V <sub>LOAD_REG_LDO4</sub>	I <sub>OUT</sub> = 0 to I <sub>OUT(MAX)</sub>	-0.5	--	0.5	%
Line Regulation	V <sub>LINE_REG_LDO3</sub> / V <sub>LINE_REG_LDO4</sub>	I <sub>OUT</sub> = 50mA/300mA, V <sub>IN_VIN3</sub> / V <sub>IN_VIN4</sub> = 3.0 to 4.4V, V <sub>OUT_LDO3</sub> / V <sub>OUT_LDO4</sub> = 1.8V	-0.5	--	0.5	%
Dropout Voltage	V <sub>DROP_LDO3</sub> / V <sub>DROP_LDO4</sub>	I <sub>OUT</sub> = 300mA, V <sub>OUT_LDO3</sub> / V <sub>OUT_LDO4</sub> = 1.8V (Note 5)	--	--	150	mV
Output Discharge Resistor	R <sub>DIS_LDO3</sub> / R <sub>DIS_LDO4</sub>		--	10	--	Ω

Parameter	Symbol	Test Conditions	Min	Typ	Max	Unit
Over-Voltage Rising Threshold Detection	OVP_R_LDO3/ OVP_R_LDO4		--	V <sub>OUT</sub> _LDO3/ V <sub>OUT</sub> _LDO4 x 120%	--	V
Over-Voltage Falling Threshold Detection	OVP_F_LDO3/ OVP_F_LDO4		--	V <sub>OUT</sub> _LDO3/ V <sub>OUT</sub> _LDO4 x 110%	--	V
Under-Voltage Rising Threshold Detection	UVP_R_LDO3/ UVP_R_LDO4		--	V <sub>OUT</sub> _LDO3/ V <sub>OUT</sub> _LDO4 x 90%	--	V
Under-Voltage Falling Threshold Detection	UVP_F_LDO3/ UVP_F_LDO4		--	V <sub>OUT</sub> _LDO3/ V <sub>OUT</sub> _LDO4 x 80%	--	V
Quiescent Current	I <sub>Q_LDO3</sub> /I <sub>Q_LDO4</sub>	HWEN = 1.2V, I <sub>OUT</sub> = 0mA	--	22	27	μA
		HWEN = 0.3V (disable)	--	0.1	1	
Short Circuit Current Limit	I <sub>sc_LDO3</sub> / I <sub>sc_LDO4</sub>		360	--	--	mA
Current Limit	I <sub>Limt_LDO3</sub> / I <sub>Limt_LDO4</sub>	0x03[3:2] = 11 (LDO3 current limit = 360mA), 0x04[3:2] = 11 (LDO4 current limit = 360mA)	360	415	470	mA
Short Protection On Timer	t <sub>scp_ON_LDO3</sub> / t <sub>scp_ON_LDO4</sub>		--	2	--	ms
Short Protection Off Timer	t <sub>scp_OFF_LDO3</sub> / t <sub>scp_OFF_LDO4</sub>		--	40	--	ms
<b>I<sup>2</sup>C Characteristics</b>						
SCL, SDA Low Input Voltage	V <sub>I<sup>2</sup>CIL</sub>		--	--	0.4	V
SCL, SDA High Input Voltage	V <sub>I<sup>2</sup>CIH</sub>		1.2	--	--	V
SCL, SDA Low Output Voltage	V <sub>I<sup>2</sup>COL</sub>		--	--	0.4	V
I <sup>2</sup> C CLK Frequency	f <sub>SCL</sub>		1	--	--	MHz
I <sup>2</sup> C Work Voltage	V <sub>I<sup>2</sup>Cint</sub>		--	1.8	--	V
Input Current Each IO Pin	I <sub>IN_I<sup>2</sup>C</sub>		-10	--	10	μA

Parameter	Symbol	Test Conditions	Min	Typ	Max	Unit
Data Hold Time	$t_{DH\_I^2C}$		30	--	--	ns
Data Set-Up Time	$t_{DS\_I^2C}$		70	--	--	ns

**Note 1.** Stresses listed as the above "Absolute Maximum Ratings" may cause permanent damage to the device. These are for stress ratings. Functional operation of the device at these or any other conditions beyond those indicated in the operational sections of the specifications is not implied. Exposure to absolute maximum rating conditions for extended periods may remain possibility to affect device reliability.

**Note 2.**  $\theta_{JA}$  is measured under natural convection (still air) at  $T_A = 25^\circ\text{C}$  with the component mounted on a high effective-thermal-conductivity four-layer test board on a JEDEC 51-7 thermal measurement standard.

**Note 3.** Devices are ESD sensitive. Handling precaution is recommended.

**Note 4.** The device is not guaranteed to function outside its operating conditions.

**Note 5.** Dropout voltage is the voltage difference between the input and the output at which the output voltage drops to 100 mV below its nominal value.

## System Characteristics

The following system specifications are guaranteed by designed and are not performed in production testing. ( $T_A = 25^\circ\text{C}$ , unless otherwise specified.)

Parameter	Symbol	Test Conditions	Min	Typ	Max	Unit
<b>System Parameter</b>						
Over-Temperature Warning	OTW		115	125	135	$^\circ\text{C}$
Over-Temperature Warning Hysteresis	OTW_H		--	20	--	$^\circ\text{C}$
Over-Temperature Protection	OTP		130	140	150	$^\circ\text{C}$
Over-Temperature Protection Hysteresis	OTP_H	0x0A[4:3] = 01	--	20	--	$^\circ\text{C}$
<b>HWEN and BSTEN Control</b>						
HWEN Turn On Delay	$t_{HWEN\_ON}$	HWEN = H to $I^2C$ operation available	--	50	--	$\mu\text{s}$
HWEN Turn Off Delay	$t_{HWEN\_OFF}$	HWEN = L to $I^2C$ operation stop	--	50	--	$\mu\text{s}$
BSTEN Turn On Delay	$t_{BSTEN\_ON}$	BSTEN to Boost voltage start rising	--	225	--	$\mu\text{s}$
BSTEN Turn Off Delay	$t_{BSTEN\_OFF}$	BSTEN off to Boost switch stop	--	16	--	$\mu\text{s}$
<b>Step Down Buck Converter (<math>V_{IN\_B} = 3.8\text{V}</math>, <math>C1 = C2 = 10\mu\text{F}</math>, <math>L1 = 1\mu\text{H}</math>)</b>						
Maximum Output Current	$I_{OUT\_BUCK}$		1.2	--	--	A
Load Regulation	$V_{LOAD\_REG\_BUCK}$	CCM, $V_{OUT\_BUCK} = 1.1\text{V}$	--	--	1.5	%
Line Regulation	$V_{LINE\_REG\_BUCK}$	CCM, $I_{OUT} = 50/300/1200\text{mA}$ , $V_{OUT\_BUCK} = 1.1\text{V}$ , $V_{IN\_B} = 3.0\text{V}$ to $4.4\text{V}$	--	--	1.5	%

Parameter	Symbol	Test Conditions	Min	Typ	Max	Unit
Output Ripple	V <sub>RIPPLE_BUCK</sub>	CCM, I <sub>OUT</sub> = 300mA, V <sub>OUT_BUCK</sub> = 1.1V, V <sub>IN_B</sub> < 4.35V	--	--	10	mV
		PFM, V <sub>OUT_BUCK</sub> = 1.1V, V <sub>IN_B</sub> < 4.35V	--	30	40	
Soft-Start Time	t <sub>SS_BUCK</sub>	0x09[7:6] = 10, time from V <sub>OUT_BUCK</sub> = 0V rising to 90% nominal value, V <sub>OUT_BUCK</sub> = 1.1V, no load	--	235	--	μs
Load Transient	V <sub>TRAN_BUCK</sub>	V <sub>OUT_BUCK</sub> = 1.1V, 20 to 80% I <sub>OUT(MAX)</sub> , 1μs, recovery time < 10μs	--	--	70	mV
Efficiency	Eff <sub>BUCK</sub>	V <sub>OUT_BUCK</sub> = 1.1V, I <sub>OUT</sub> = 200mA to 600mA	85	--	--	%
<b>Step Up Boost Converter (V<sub>IN_BST</sub> = 3.8V, C3 = 10μF, C4 = 22μF, L2 = 0.47μH)</b>						
Maximum Output Current	I <sub>OUT_BST</sub>	V <sub>IN_BST</sub> = 2.8V, V <sub>OUT_BST</sub> = 5V	1	--	--	A
Soft-Start Time	t <sub>SS_BST</sub>	0x05[5:4] = 00, time from V <sub>OUT_BST</sub> = 0V rising to 90% nominal value, V <sub>OUT_BST</sub> = 5V, no load	--	--	580	μs
Start Up Time	t <sub>START_BST</sub>	Time from BSTEN = H to V <sub>OUT_BST</sub> rising to 90% nominal value, V <sub>OUT_BST</sub> = 5V, no load	--	--	700	μs
Load Regulation	V <sub>LOAD_REG_BST</sub>	CCM, V <sub>OUT_BST</sub> = 5V	--	--	1.5	%
Line Regulation	V <sub>LINE_REG_BST</sub>	CCM, I <sub>OUT</sub> = 50/1000mA, V <sub>IN_BST</sub> = 3V to 4.4V, V <sub>OUT_BST</sub> = 5V	--	--	1.5	%
Output Ripple	V <sub>RIPPLE_BST</sub>	CCM, I <sub>OUT</sub> = 500mA, V <sub>IN_BST</sub> = 3.4V to 4.4V, V <sub>OUT_BST</sub> = 5V	--	--	40	mV
		PFM, V <sub>IN_BST</sub> = 3.4V to 4.4V, V <sub>OUT_BST</sub> = 5V	--	40	80	
Load Transient	V <sub>TRAN_BST</sub>	V <sub>OUT_BST</sub> = 5V, 20 to 80% I <sub>OUT(MAX)</sub> , 2μs, recovery time < 30μs	--	100	150	mV
Power Efficiency	Eff <sub>BST</sub>	V <sub>OUT_BST</sub> = 5V, V <sub>IN_BST</sub> = 3.4V, I <sub>OUT_BST</sub> = 10mA	--	88	--	%
		V <sub>OUT_BST</sub> = 5V, V <sub>IN_BST</sub> = 3.4V, I <sub>OUT_BST</sub> = 600mA	--	90	--	
		V <sub>OUT_BST</sub> = 5V, V <sub>IN_BST</sub> = 3.4V, I <sub>OUT_BST</sub> = 1A	--	84	--	
Linear Charge Hiccup On Time	t <sub>LC_ON</sub>	During linear charge state	--	10	--	ms

Parameter	Symbol	Test Conditions	Min	Typ	Max	Unit
Linear Charge Hiccup Off Time	$t_{LC\_OFF}$	Restart linear charge	--	100	--	ms
ABS Output Over-Voltage Rising Threshold	OVP_R_ABS_BST	Stop switch	--	6.5	--	V
ABS Output Over-Voltage Falling Threshold	OVP_F_ABS_BST	Start switch	--	5.8	--	V
<b>Low Dropout Voltage Regulator LDO1 and LDO2 (<math>V_{IN\_VIN12} = V_{OUT\_LDO1}/V_{OUT\_LDO2} + 1V</math>, <math>V_{HWEN} = 1.2V</math>, <math>I_{OUT} = 1mA</math>, <math>C_{IN} = 2.2\mu F</math>, <math>C_{OUT} = 2.2\mu F</math>)</b>						
Output Ripple Voltage	$V_{RIPPLE\_LDO1}/V_{RIPPLE\_LDO2}$	$I_{OUT} = 0$ to $I_{OUT(MAX)}$ , $V_{OUT\_LDO1}/V_{OUT\_LDO2} = 2.8V$	--	--	10	mV
Load Transient	$V_{TRAN\_LDO1}/V_{TRAN\_LDO2}$	$I_{OUT} = 1mA$ to $150mA$ , $150mA/\mu s$ , $V_{OUT\_LDO1}/V_{OUT\_LDO2} = 2.8V$	--	--	50	mV
Power Supply Rejection Ratio	PSRR_LDO1/ PSRR_LDO2	$V_{IN\_VIN12} = 3.4V$ , $f = 1kHz$ , $I_{OUT} = 100mA$ , $V_{OUT\_LDO1}/V_{OUT\_LDO2} = 2.8V$	70	--	--	dB
		$V_{IN\_VIN12} = 3.4V$ , $f = 100kHz$ , $I_{OUT} = 100mA$ , $V_{OUT\_LDO1}/V_{OUT\_LDO2} = 2.8V$	40	--	--	
Output Noise Voltage	$e_{N\_LDO1}/e_{N\_LDO2}$	100Hz to 100kHz, $I_{OUT} = 100mA$ , $V_{OUT\_LDO1}/V_{OUT\_LDO2} = 2.8V$	--	50	--	$\mu V$
<b>Low Dropout Voltage Regulator LDO3 and LDO4 (<math>V_{IN\_VIN3}/V_{IN\_VIN4} = V_{OUT\_LDO3}/V_{OUT\_LDO4} + 1V</math>, <math>V_{HWEN} = 1.2V</math>, <math>I_{OUT} = 1mA</math>, <math>C_{IN} = 2.2\mu F</math>, <math>C_{OUT} = 2.2\mu F</math>)</b>						
Output Ripple Voltage	$V_{RIPPLE\_LDO3}/V_{RIPPLE\_LDO4}$	$I_{OUT} = 0$ to $I_{OUT(MAX)}$ , $V_{OUT\_LDO3}/V_{OUT\_LDO4} = 1.8V$	--	--	10	mV
Load Transient	$V_{TRAN\_LDO3}/V_{TRAN\_LDO4}$	$I_{OUT} = 1mA$ to $150mA$ , $150mA/\mu s$ , $V_{OUT\_LDO3}/V_{OUT\_LDO4} = 1.8V$	--	--	50	mV
Power Supply Rejection Ratio	PSRR_LDO3/ PSRR_LDO4	$V_{IN\_VIN3} / V_{IN\_VIN4} = 1.95V$ , $f = 1kHz$ , $I_{OUT} = 100mA$ , $V_{OUT\_LDO3}/V_{OUT\_LDO4} = 1.8V$	50	--	--	dB
		$V_{IN\_VIN3} / V_{IN\_VIN4} = 1.95V$ , $f = 10kHz$ , $I_{OUT} = 100mA$ , $V_{OUT\_LDO3}/V_{OUT\_LDO4} = 1.8V$	40	--	--	
Output Noise Voltage	$e_{N\_LDO3}/e_{N\_LDO4}$	100Hz to 100kHz, $I_{OUT} = 100mA$ , $V_{OUT\_LDO3}/V_{OUT\_LDO4} = 1.8V$	--	50	--	$\mu V$

## Typical Operating Characteristics

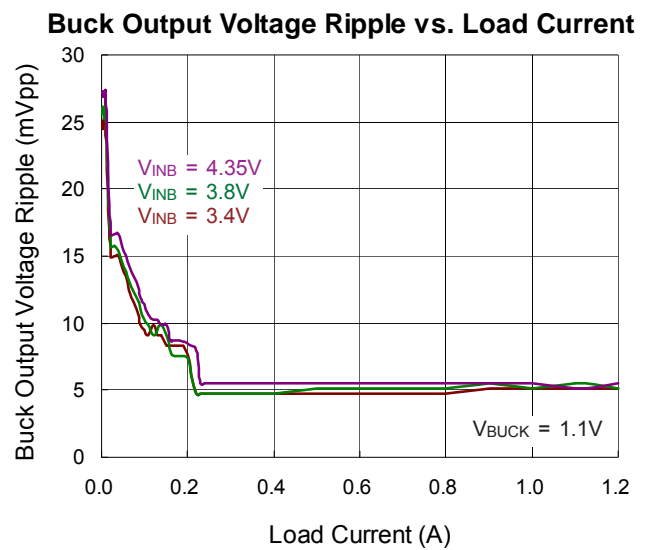
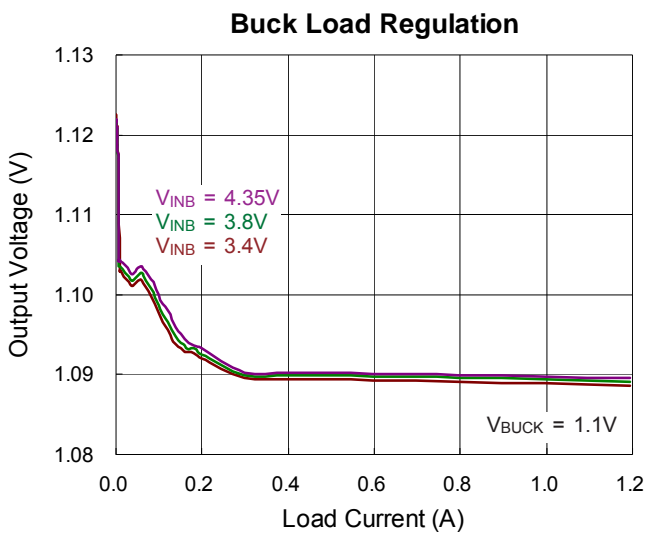
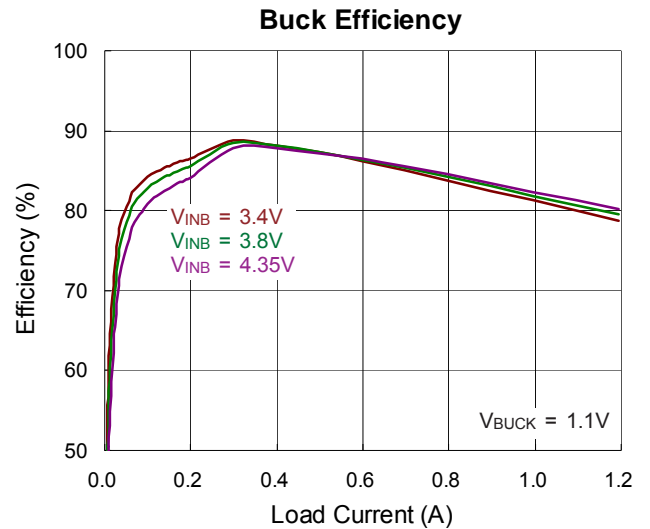
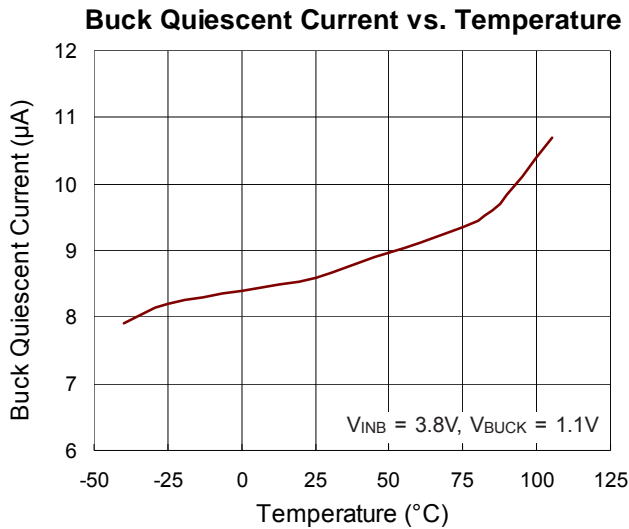
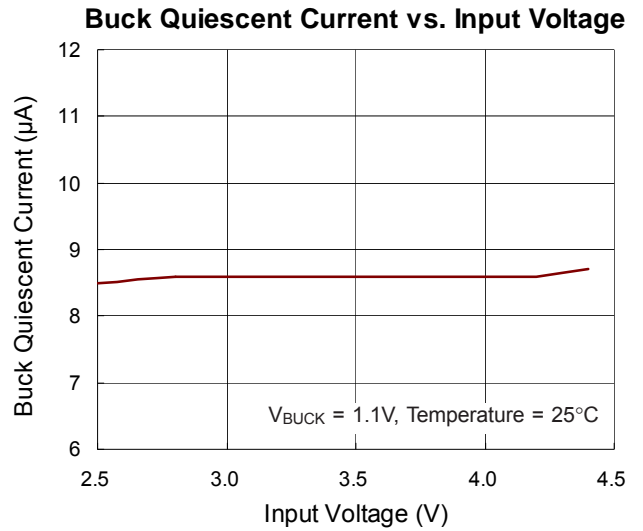
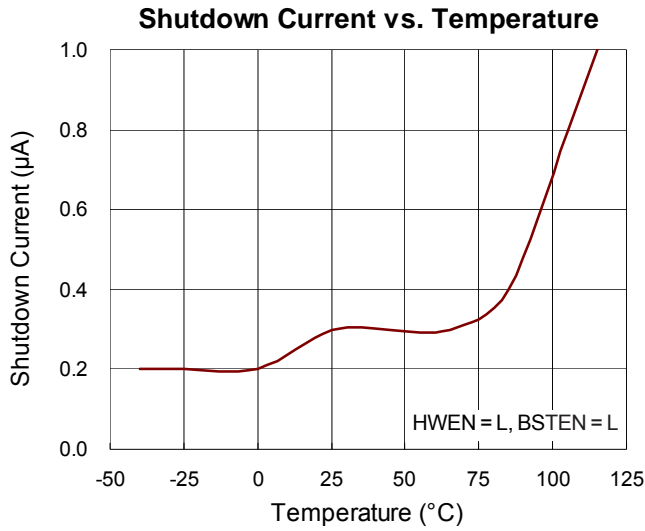

Buck Switching Frequency vs. Load Current

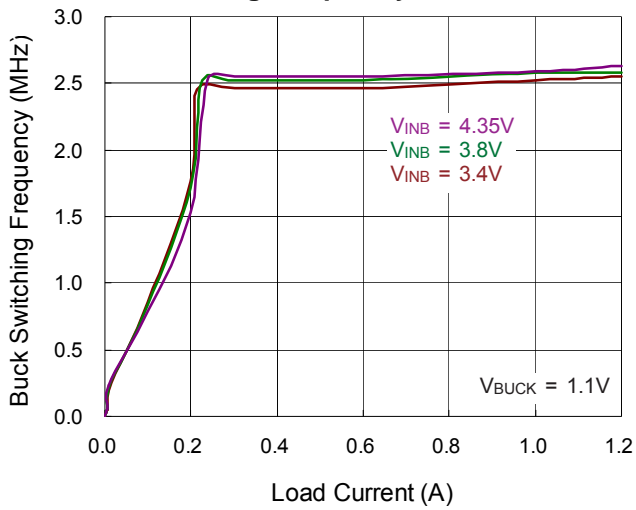

Buck Power On

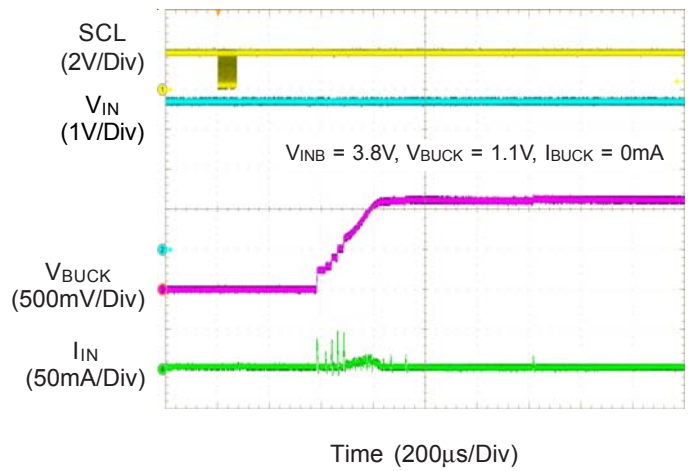

Buck Power Off

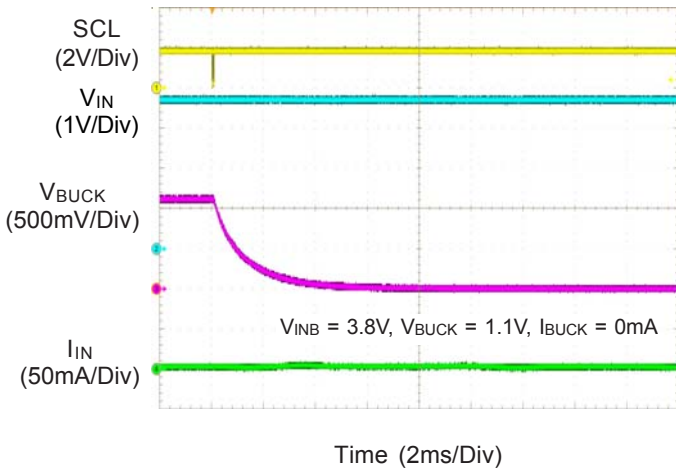

Buck Load Transient

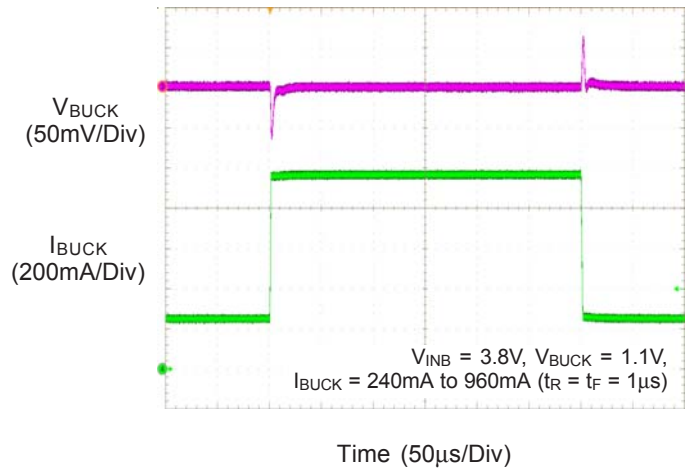

Boost Quiescent Current vs. Input Voltage

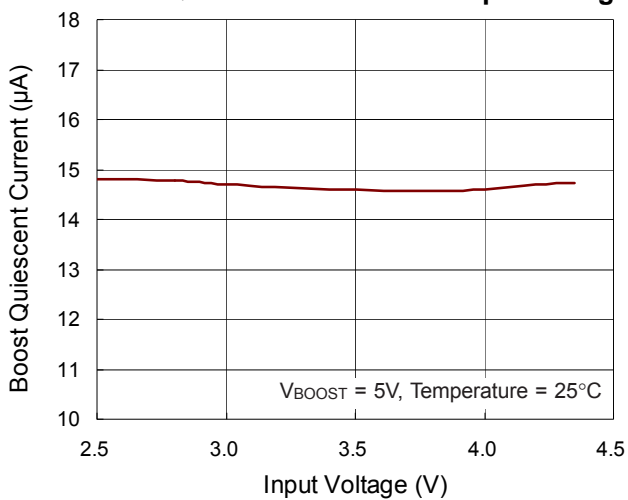

Boost Quiescent Current vs. Temperature

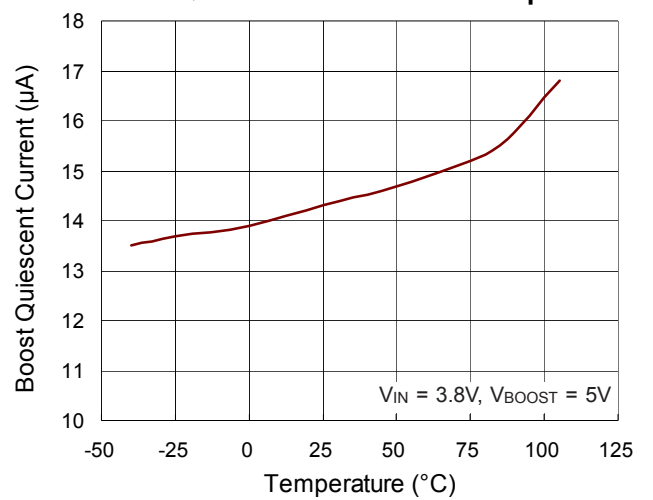

Boost Efficiency

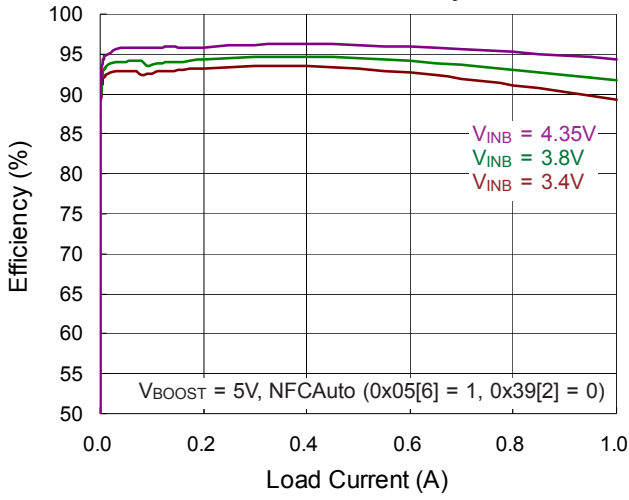

Boost Efficiency

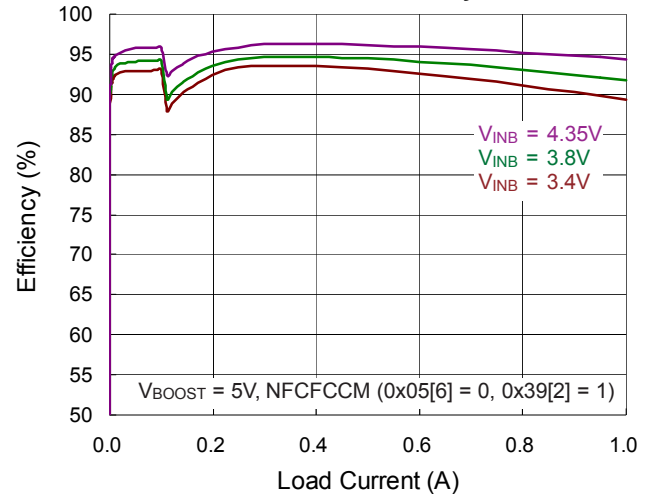

Boost Load Regulation

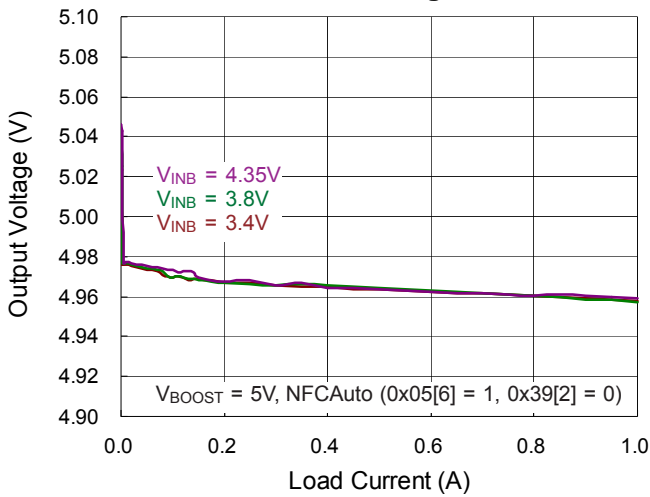

Boost Load Regulation

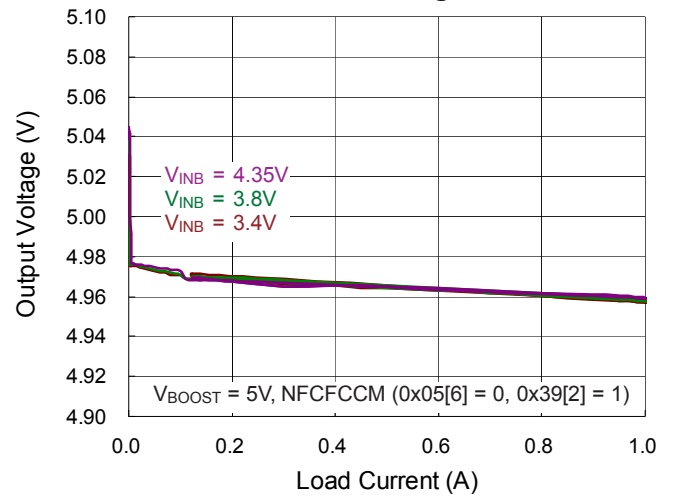

Boost Output Voltage Ripple vs. Load Current

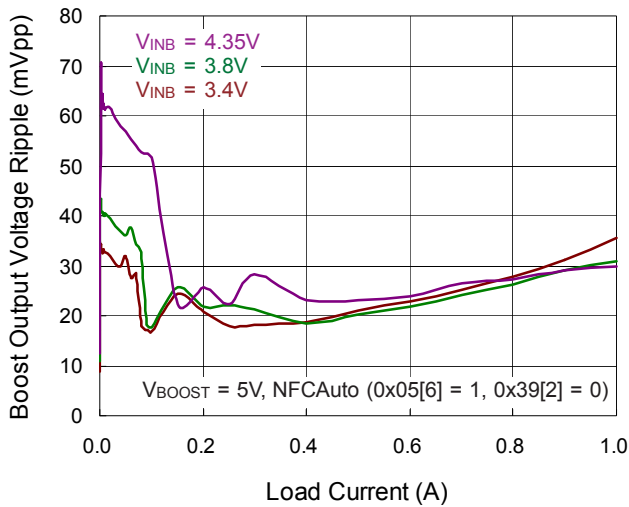

Boost Output Voltage Ripple vs. Load Current

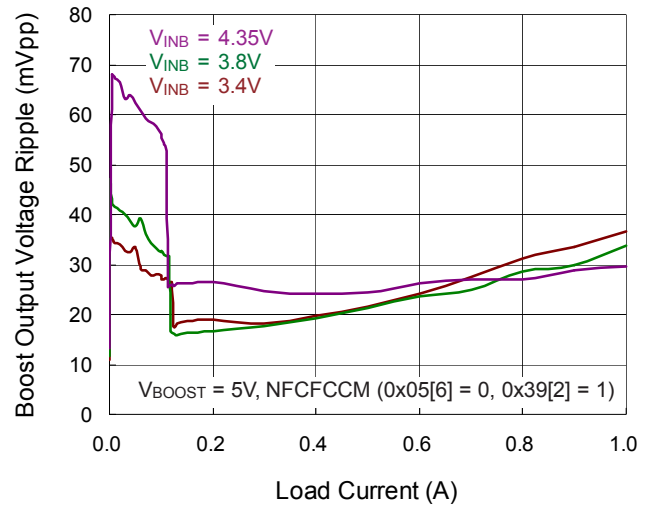



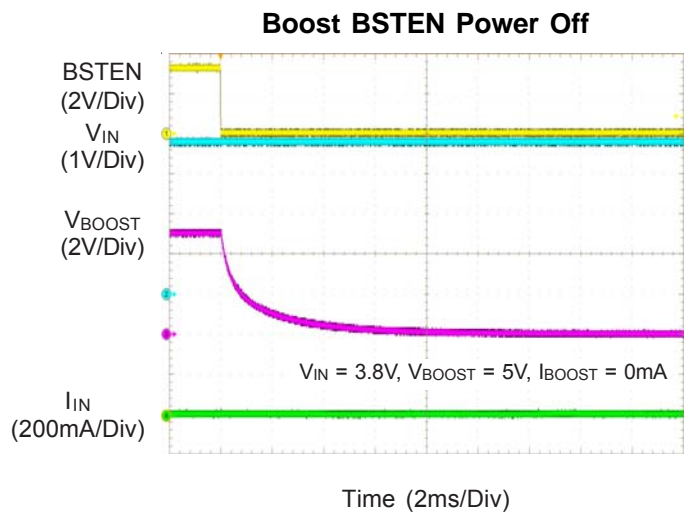
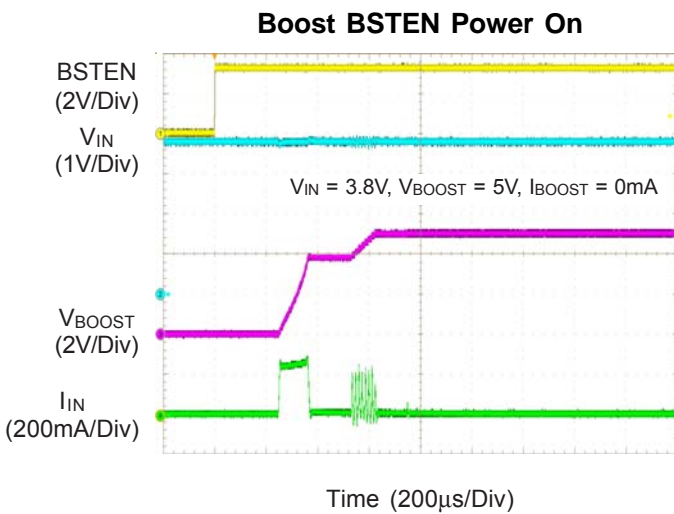
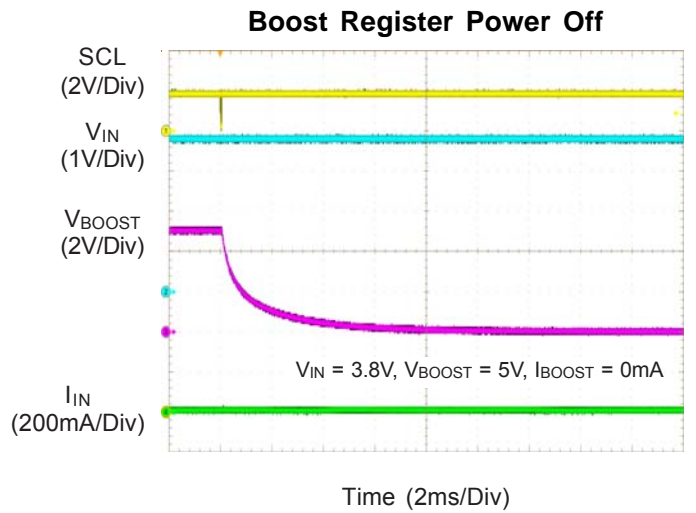
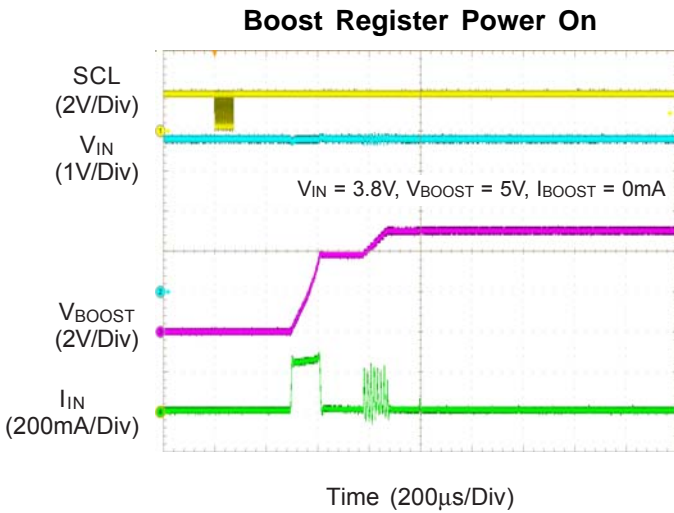
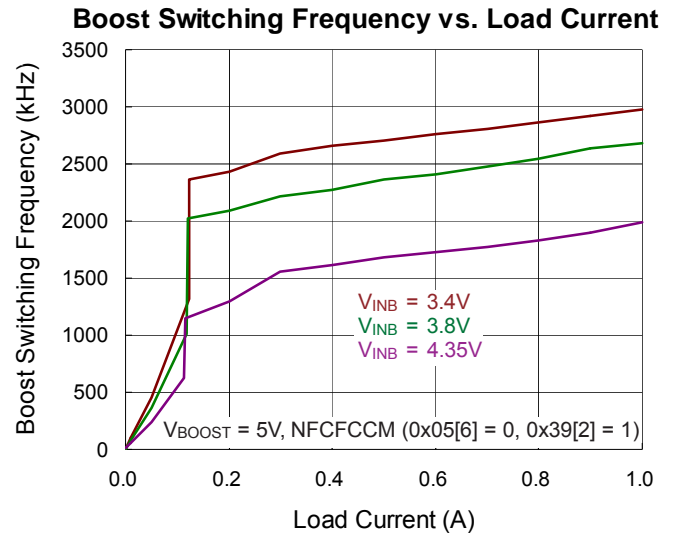
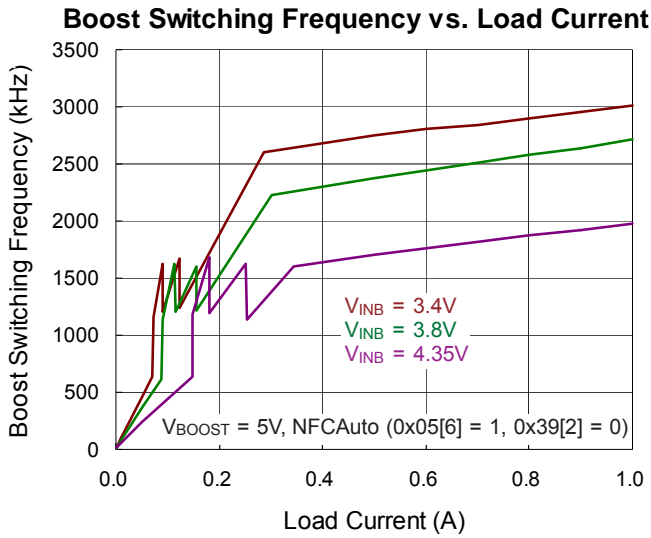

### Boost Load Transient

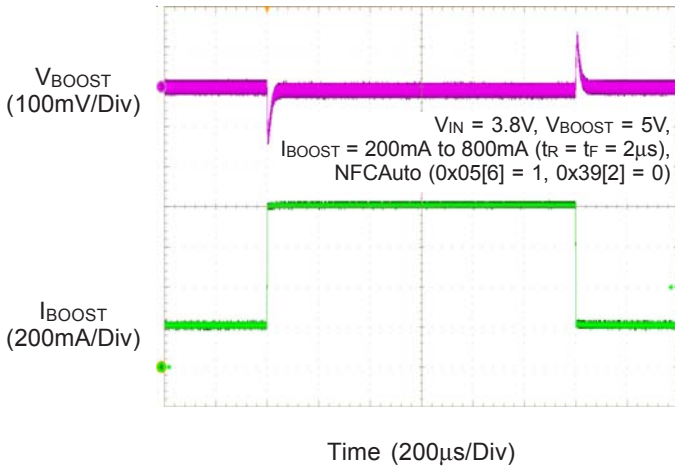

### Boost Load Transient

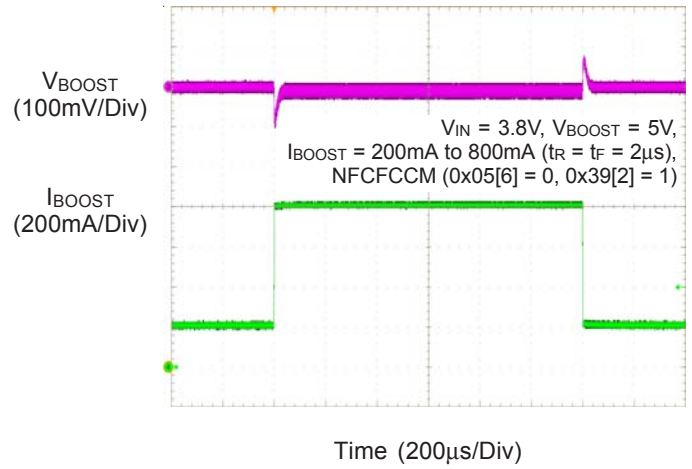

### LDO Quiescent Current vs. Input Voltage

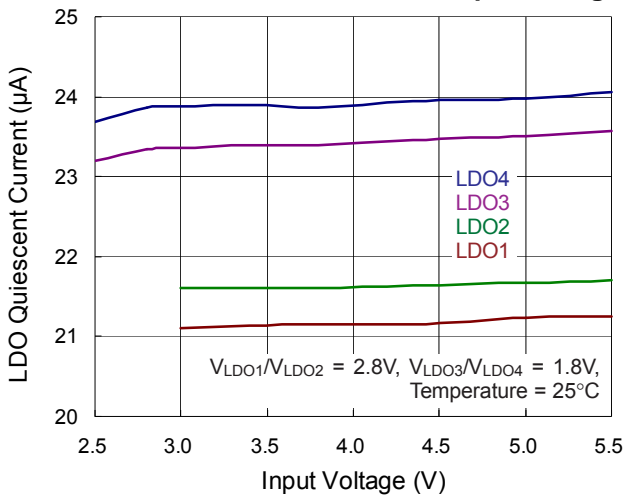

### LDO Quiescent Current vs. Temperature

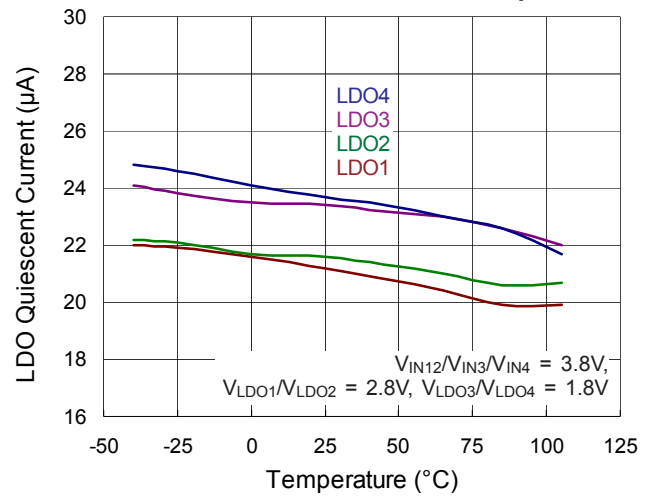

### LDO1 Load Regulation

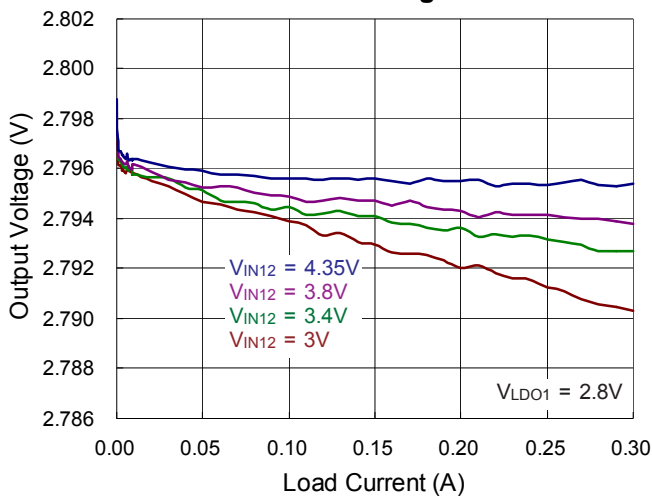

### LDO2 Load Regulation

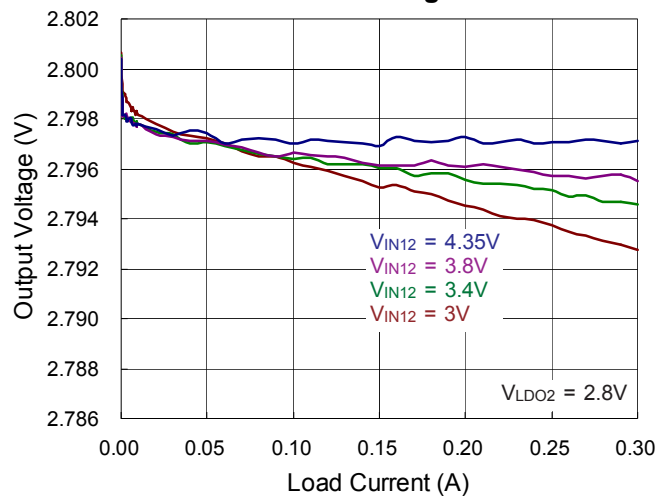

**LDO3 Load Regulation**

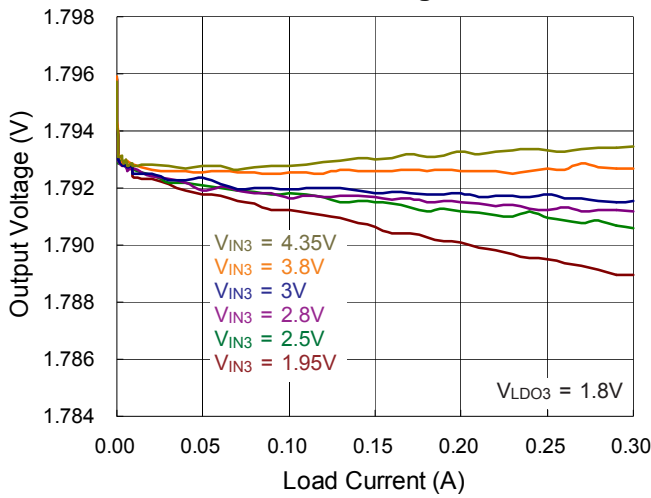

**LDO4 Load Regulation**

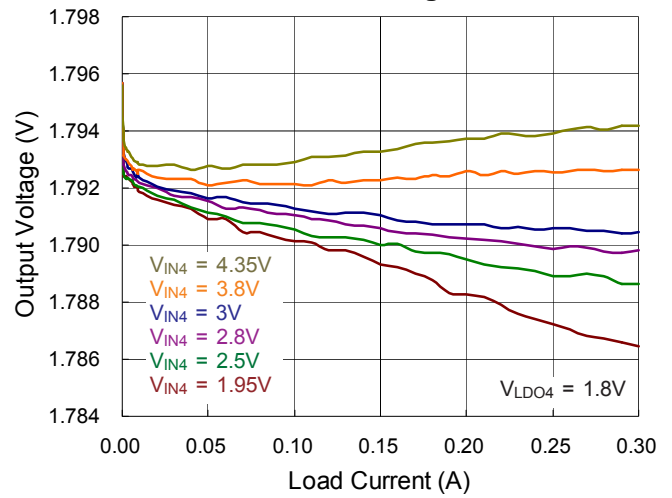

**LDO1 Dropout Voltage vs. Load Current**

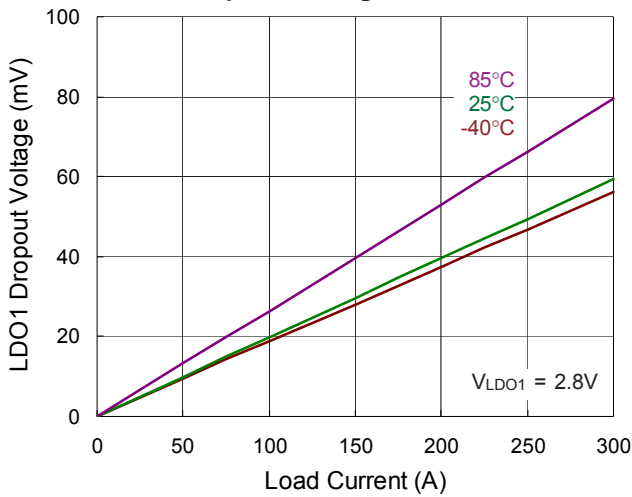

**LDO2 Dropout Voltage vs. Load Current**

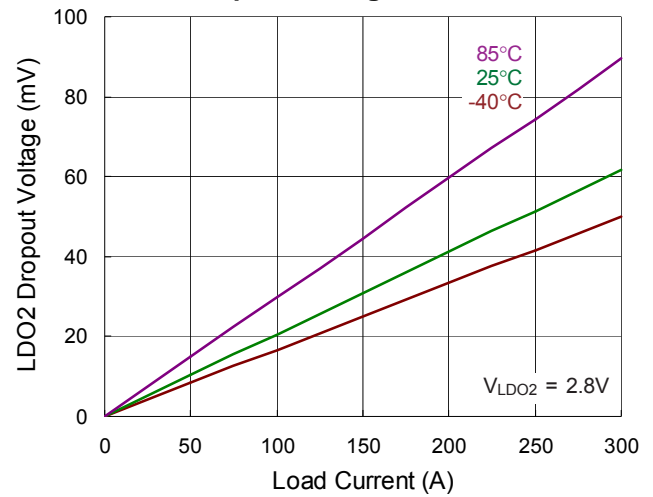

**LDO3 Dropout Voltage vs. Load Current**

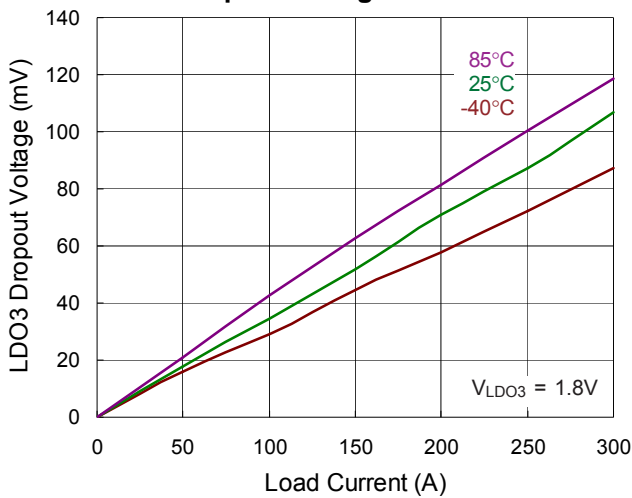

**LDO4 Dropout Voltage vs. Load Current**

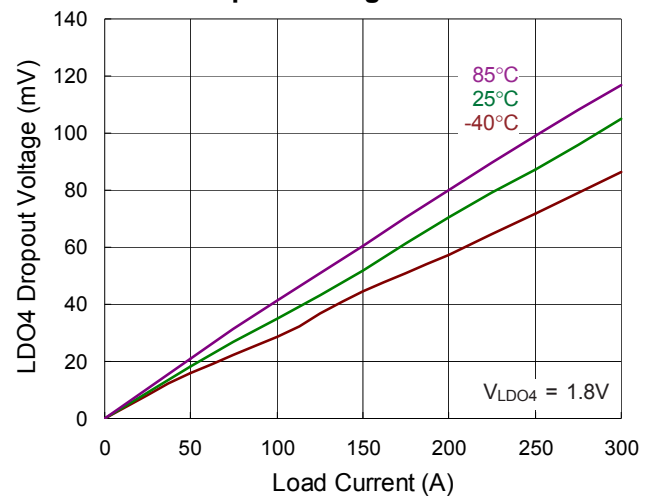

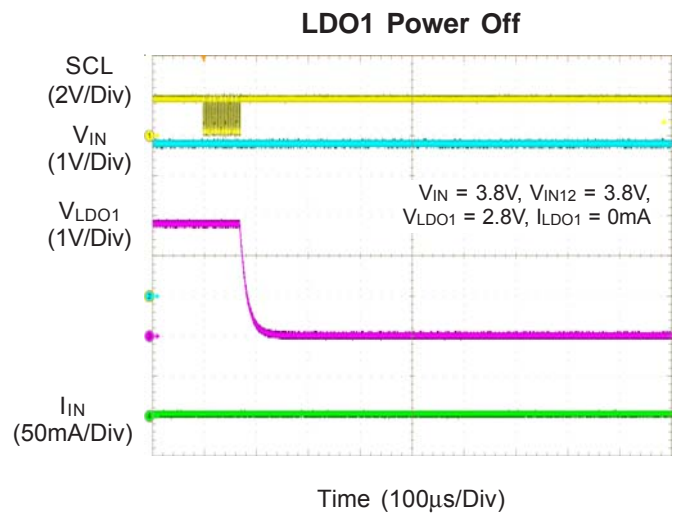
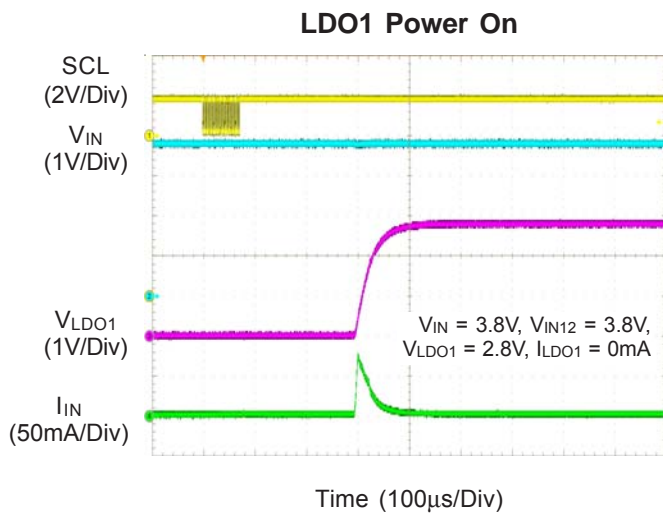
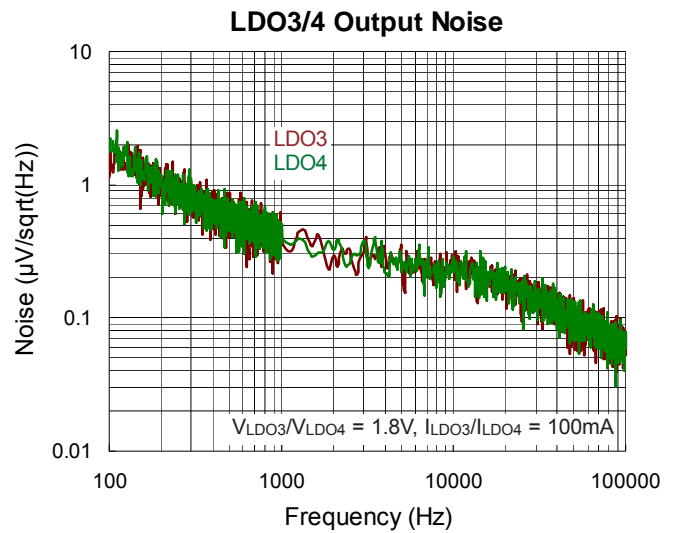
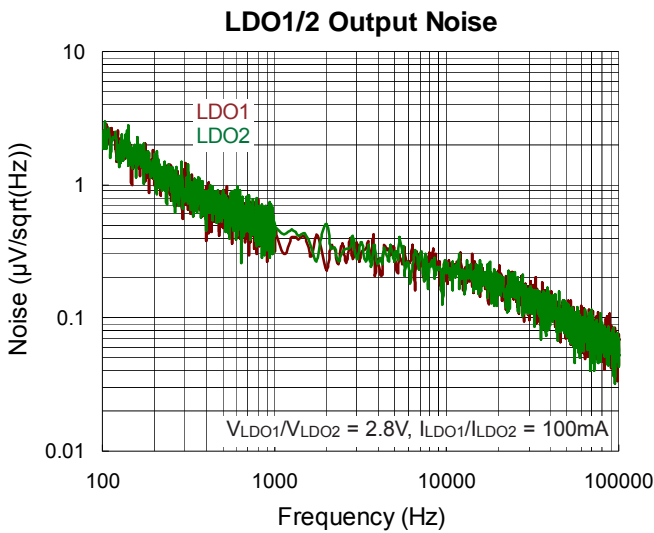
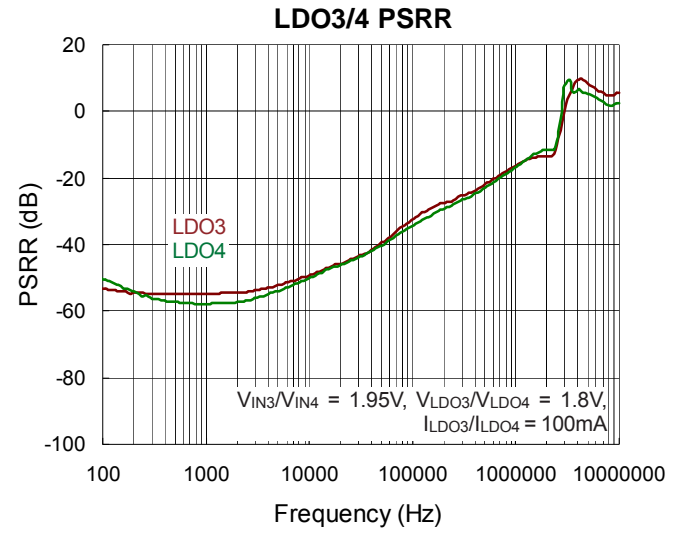
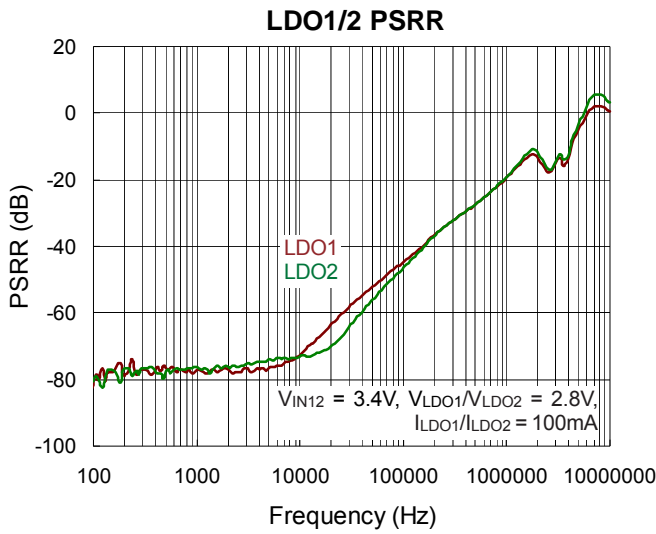

LDO2 Power On

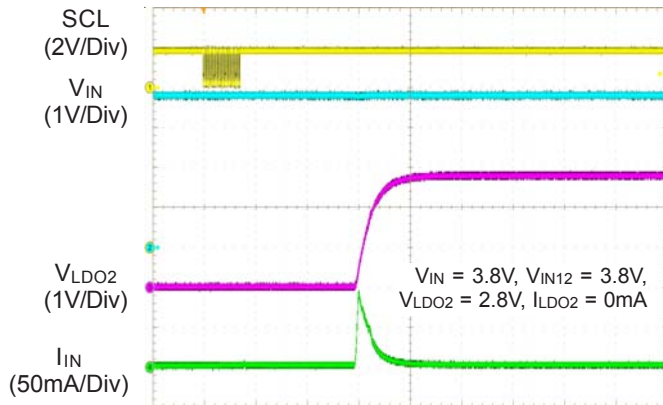

Time (100 $\mu$ s/Div)

LDO2 Power Off

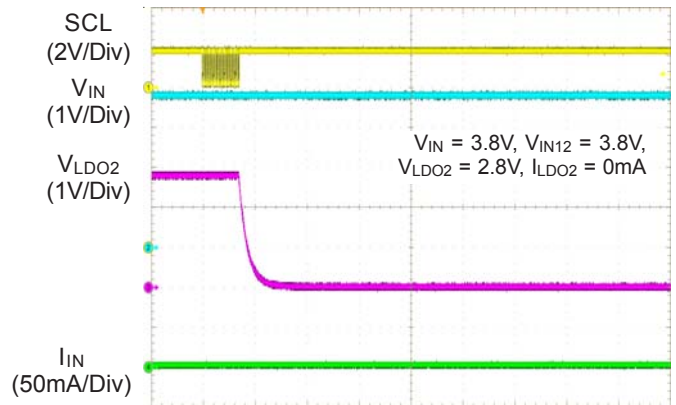

Time (100 $\mu$ s/Div)

LDO3 Power On

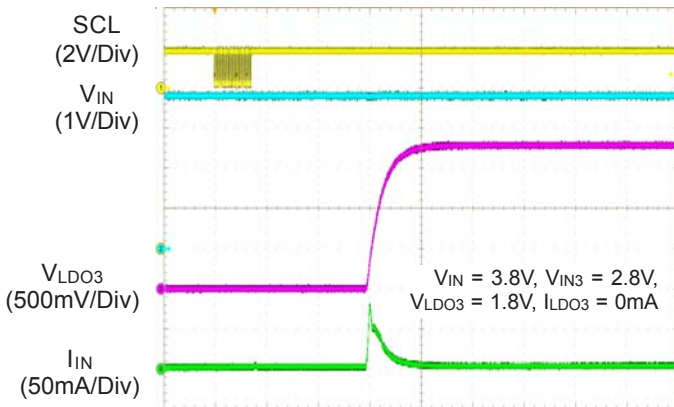

Time (100 $\mu$ s/Div)

LDO3 Power Off

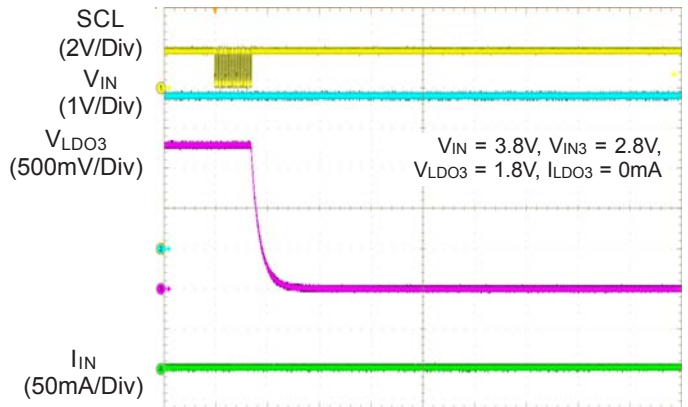

Time (100 $\mu$ s/Div)

LDO4 Power On

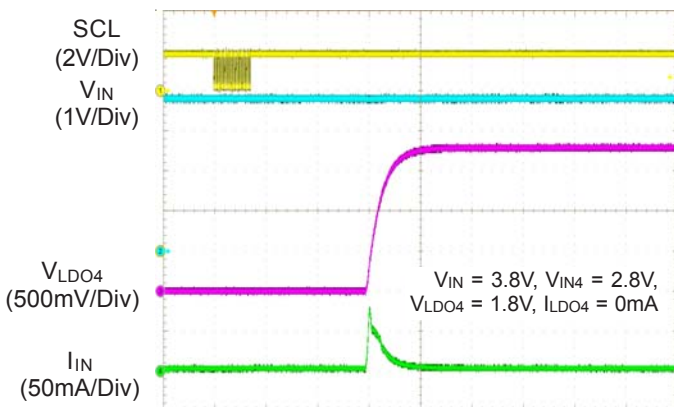

Time (100 $\mu$ s/Div)

LDO4 Power Off

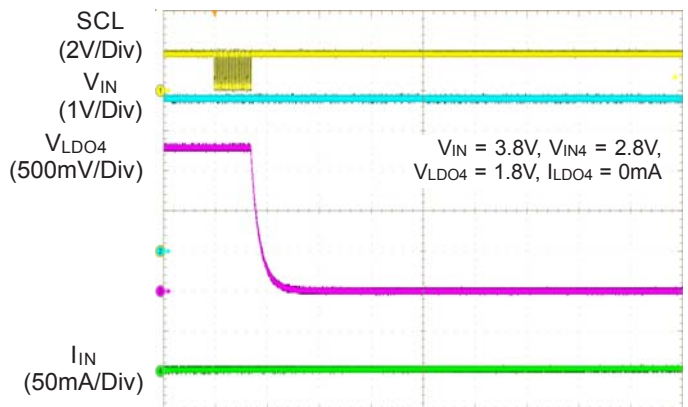

Time (100 $\mu$ s/Div)

### LDO1 Load Transient

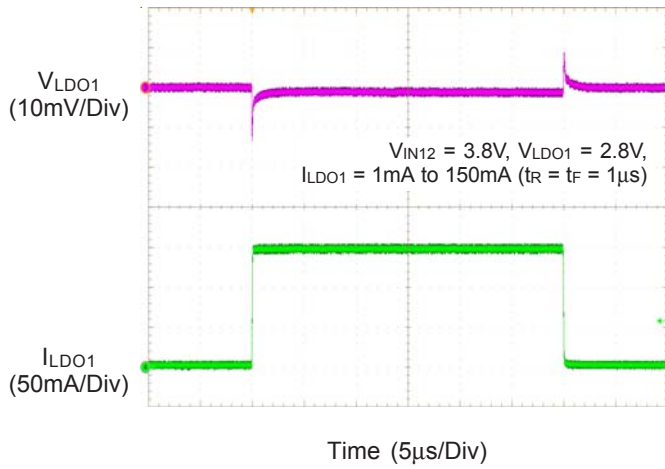

### LDO2 Load Transient

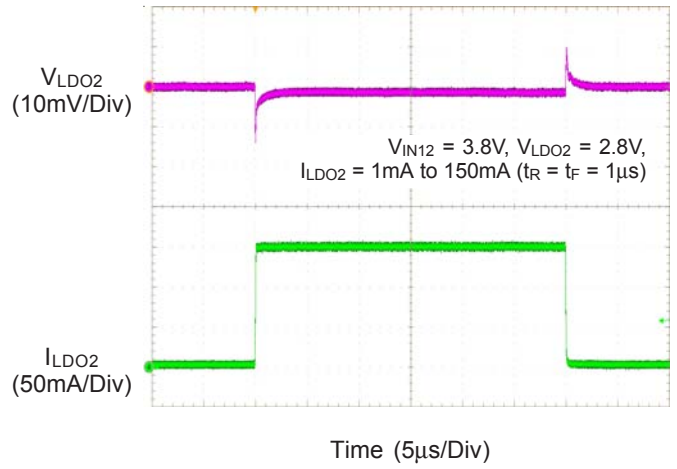

### LDO3 Load Transient

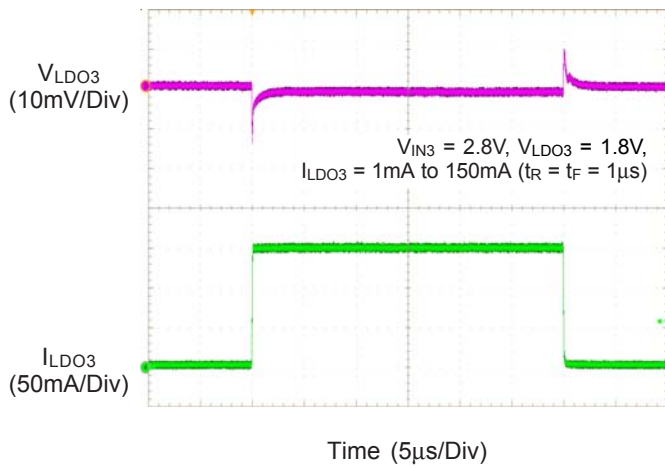

### LDO4 Load Transient

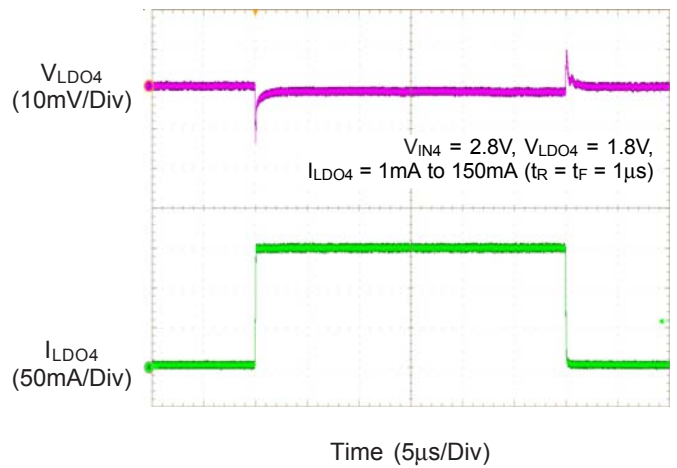

## Application Information

The RT5112H is a smart power-management integrated circuit (PMIC), which includes a Buck converter, a Boost converter and four LDOs.

### System Under-Voltage Protection and Over-Voltage Protection

The device does not operate with  $V_{SYS}$  voltages below the Under-Voltage Lock Out (UVLO) level. There is a typical 100mV hysteresis implemented to avoid unstable on/ off behavior. The RT5112H is initialized in its default state after  $V_{SYS}$  voltage recovers from UVLO. When  $V_{SYS}$  voltage reaches the Over Voltage Protection level, the RT5112H will disable Buck converter immediately to protect next stage circuit input. The  $V_{SYS}$  UV and OV status bits and interrupt bits will be set, and INTRB pin will be pulled low with corresponding to protection detected.

### Thermal Protection

The RT5112H features over-temperature warning (OTW) and over-temperature protection (OTP). The OTW status bit and interrupt bit are set and INTRB pin will be pulled low when the junction temperature is higher than typical 125°C. If the junction temperature further exceeds typical 160°C, OTP will be triggered to shut down the device.

When the RT5112H recovers from OTP, it can re-start in three configurations with register 0x0A[4:3] bits.

- 0x0A[4:3] = 00, the RT5112H is manual re-start with default register values.
- 0x0A[4:3] = 01, the RT5112H is auto recovery with last register values before OTP.
- 0x0A[4:3] = 10, the RT5112H is latched off. Re-set  $V_{IN}$  or HWEN or BSTEN (if Boost is controlled by BSTEN) to re-start the RT5112H with default register values.

### Enable and Disable Control

The HWEN pin controls the RT5112H start up without enabling channels. If HWEN pin is at low state, the RT5112H is in power down mode and I<sup>2</sup>C will return NACK to any request. Only when HWEN pin is at high state, all channels are controllable via I<sup>2</sup>C with corresponding ENABLE command. The BSTEN pin is only used to hardware control Boost converter enable or disable. There are both built-in resistors on HWEN and BSTEN pins to keep at low state if pins are left unconnected.

The below tables provide channels state with combinations of different ENABLE pins and register EN bits.

- **Buck and LDOs**

**Table 1. Buck and LDOs Control**

HWEN pin	SEQ bits	EN bits	SEQ_CTRL bits Dependent	On / Off
Low	000	0	No	Off
Low	000	1	No	Off
Low	≠000	0	No	Off
Low	≠000	1	No	Off
High	000	0	No	Off
High	000	1	No	On
High	≠000	0	Yes	On
High	≠000	1	CTRL	On / Off

Note : CTRL indicates several operating conditions as below.

(1) SEQ\_CTRL[1:0] = 00, set SEQ bits ≠ 000 and EN bit = 1, channel is turned off after 7 sequence slot count regardless EN bit.

(2) SEQ\_CTRL[1:0] = 01, set SEQ bits 000 and EN bit = 1, channel is turned on depends on EN bit.

### ▶ Sequence Control Setting

The RT5112H Buck and LDOs sequence on/off control setting can be programmed via I<sup>2</sup>C with dedicated registers as below.

#### ◆ Sequence (7 slots)

Register 0x00[6:4] is used to control Buck sequence on/off slot.

Registers 0x01[6:4], 0x02[6:4], 0x03[6:4] and 0x04[6:4] are used to control LDOs sequence on/off slots.

#### ◆ Slot Interval Time

Register 0x09[7:6] is used to control interval time between each slot.

#### ◆ Soft Start Time

Register 0x09[7:6] is used to control Buck sequence on soft start time.

Register 0x11[1:0] is used to control LDOs sequence on soft start time.

#### ◆ Sequence Control

Register 0x09[5:4] = 00 is used to enable sequence off with sequence setting  $\neq$  000.

Register 0x09[5:4] = 01 is used to enable sequence on with sequence setting 000.

Note :

(1) Any changes in Sequence (7 slots), slot interval time and soft-start time during sequence on or off procedure is not valid and will not modify the RT5112H setting.

(2) Channel setting (output voltage, current limit...etc.) is fixed during on or off sequence.

(3) Register 0x09[5:4] = 11 will turn off all channels immediately.

(4) HWEN = 0 will turn off all channels and the RT5112H enters into power down mode.

### ▶ Normal Control Setting

When register bits 0x09[5:4] = 10, the Buck and LDOs on/off control depends on channel Enable bit.

◆ Register 0x00[7] is used to control Buck on/off.

◆ Register 0x01[7], 0x02[7], 0x03[7] and 0x04[7] are used to control LDOs on/off.

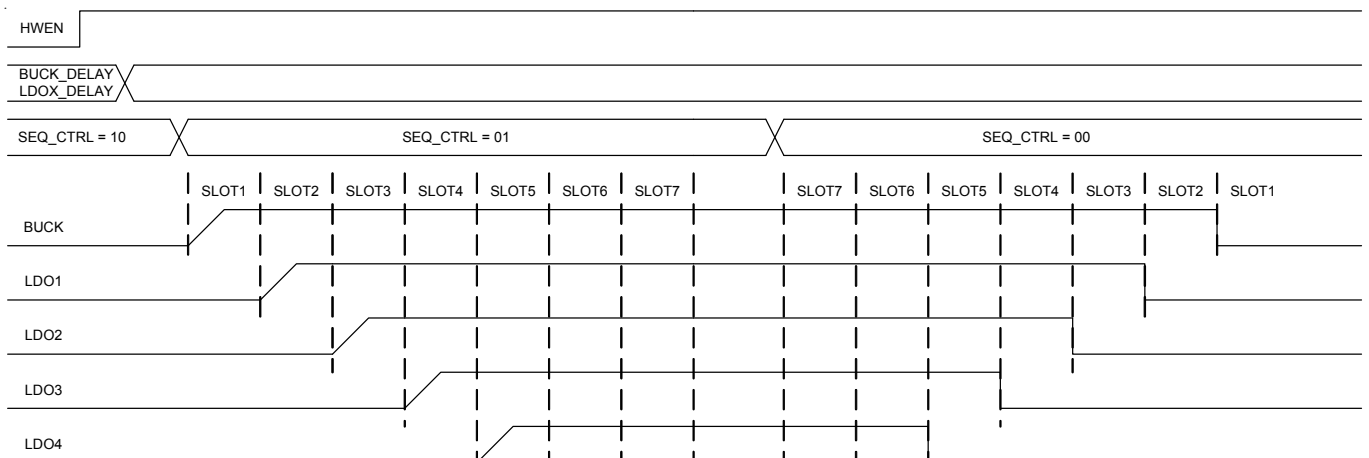

Figure 1.

Example for sequence on/off with BUCK assign to SLOT1, LDO1 assign to SLOT2, LDO2 assign to SLOT3, LDO3 assign to SLOT4 and LDO4 assign to SLOT5.



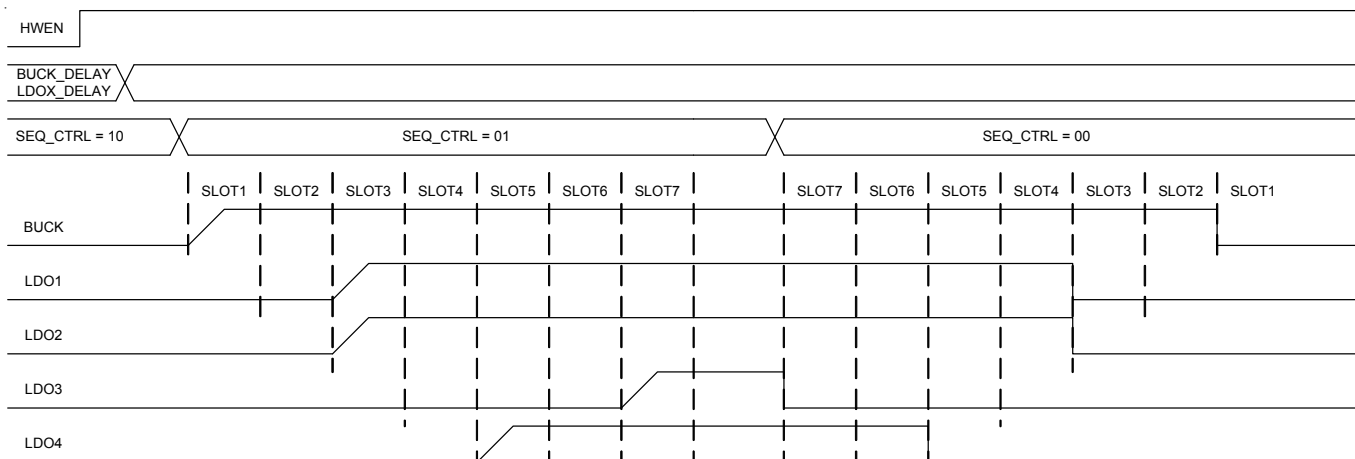

Figure 2.

Example for sequence on/off with BUCK assign to SLOTT1, LDO1 assign to SLOTT3, LDO2 assign to SLOTT3, LDO3 assign to SLOTT7 and LDO4 assign to SLOTT5.

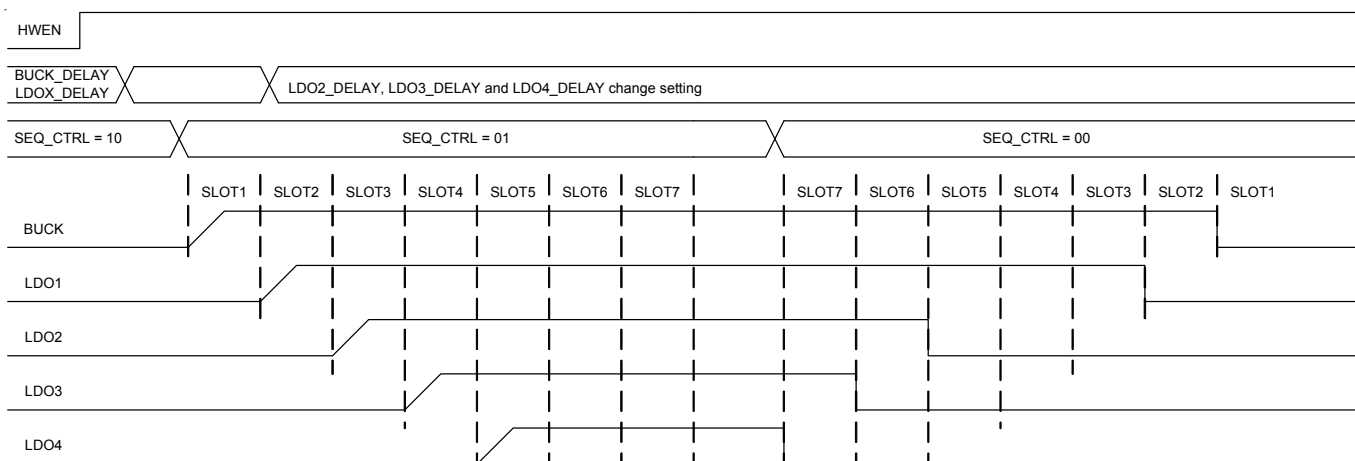

Figure 3.

Example for sequence slot change when on procedure. LDO2 assign from SLOTT3 to SLOTT5, LDO3 assign from SLOTT4 to SLOTT6 and LDO4 assign from SLOTT5 to SLOTT7. There is no influence with on procedure and new setting will executed after on sequence finish.

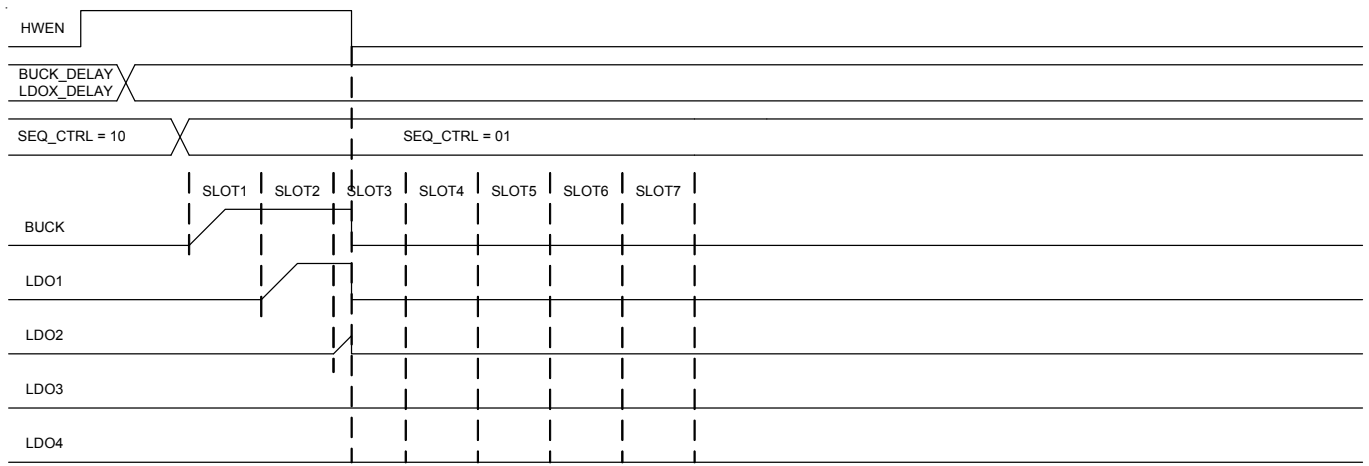

Figure 4.

Example for sequence on is interrupted by HWEN signal low. The RT5112H turns off all channels immediately.

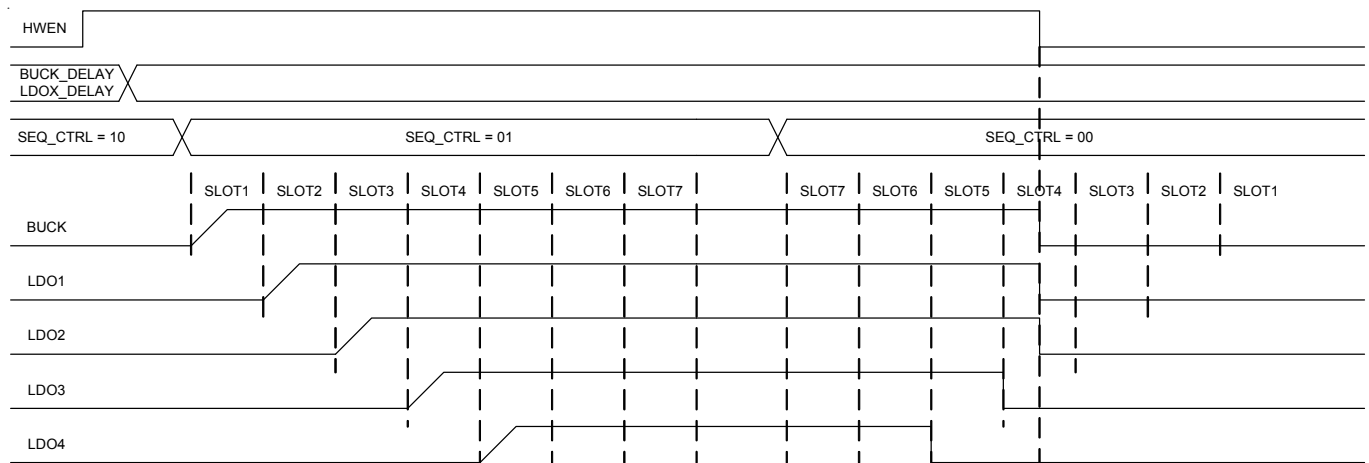

Figure 5.

Example for sequence off is interrupted by HWEN signal low. The RT5112H turns off all channels immediately.

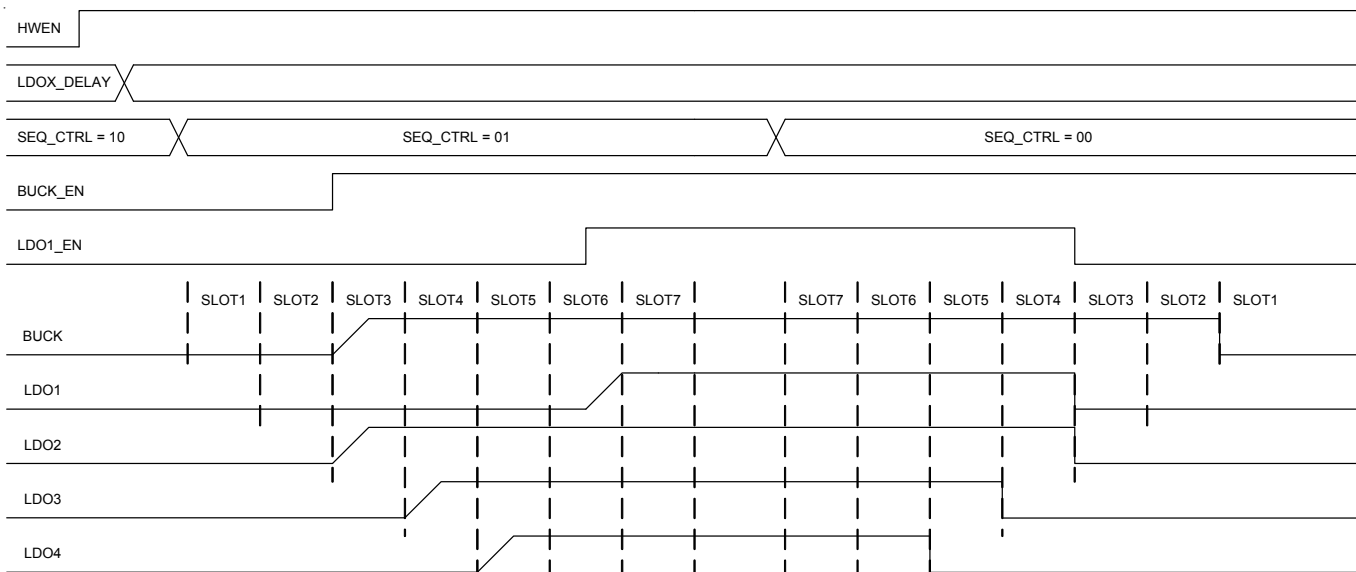

Figure 6.

Example for sequence control SEQ\_CTRL change from 01 to 00. LDO2, LDO3, LDO4 are sequence off and LDO1 is turned off by itself enable bit. BUCK1 is turned off after 7 sequence slot count even itself enable bit is at high state.

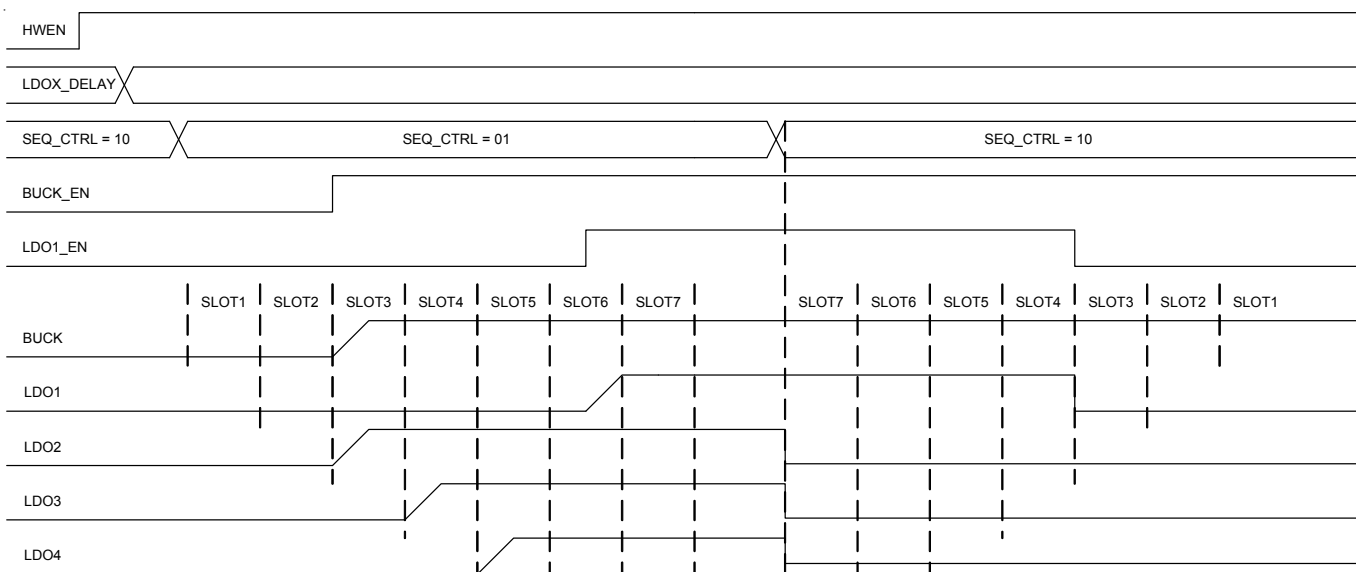

Figure 7.

Example for sequence control SEQ\_CTRL change from 01 to 10. LDO2, LDO3, LDO4 are turned off and state of BUCK, LDO1 depends on itself enable bit.

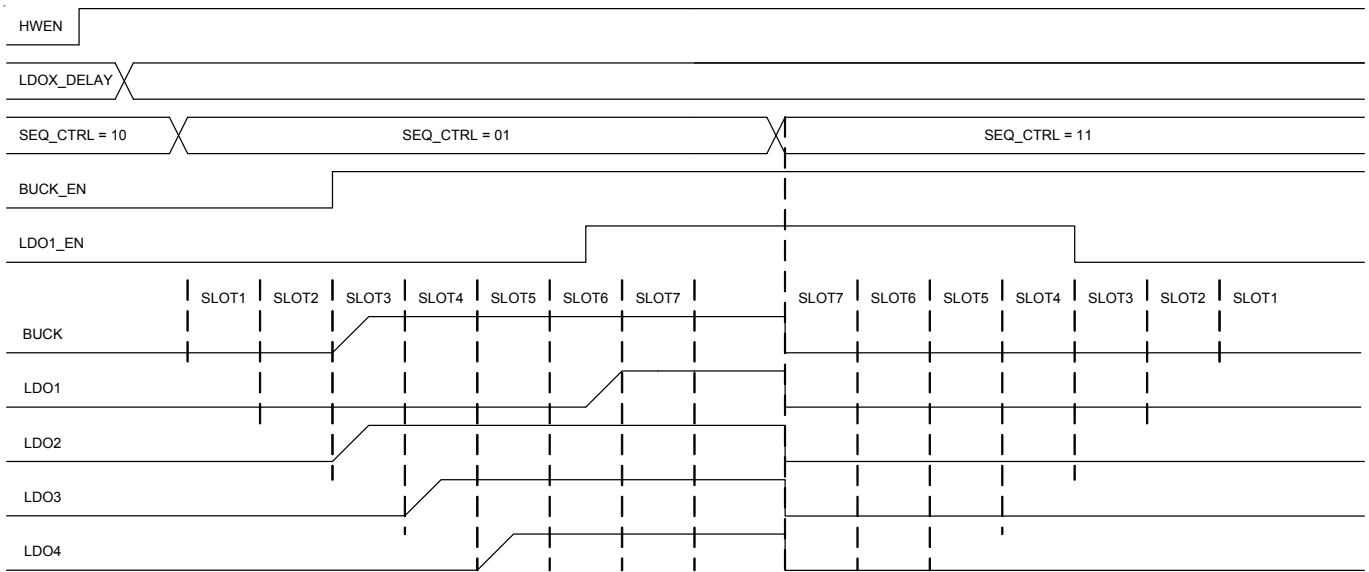

Figure 8.

Example for sequence control SEQ\_CTRL change from 01 to 11. All channels are turned off immediately.

• Boost

Table 2. Boost Control

HWEN pin	BSTEN pin	EN bits	On / Off
Low	Low	0	Off
Low	Low	1	Off
Low	High	0	On
Low	High	1	On
High	Low	0	Off
High	Low	1	On
High	High	0	On
High	High	1	On

Note : The Boost Control table above shows that the Boost operation requires either BSTEN pin to be high or a combination of HWEN pin high and one of the EN bits in register 0x08 needs to be set to 1.

► Normal Control Setting

The RT5112H Boost on/off control setting can be programmed via I<sup>2</sup>C with dedicated registers or external BSTEN pin.

- ◆ BSTEN pin to hardware control on/off.
- ◆ Register 0x08[7] to 0x08[0], each bit is able to software control on/off.

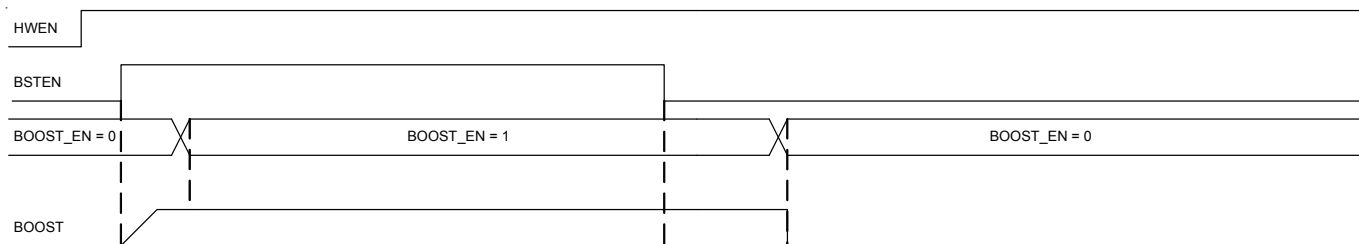

Figure 9.

Example for normal control with combination of BSTEN pin and EN bits.

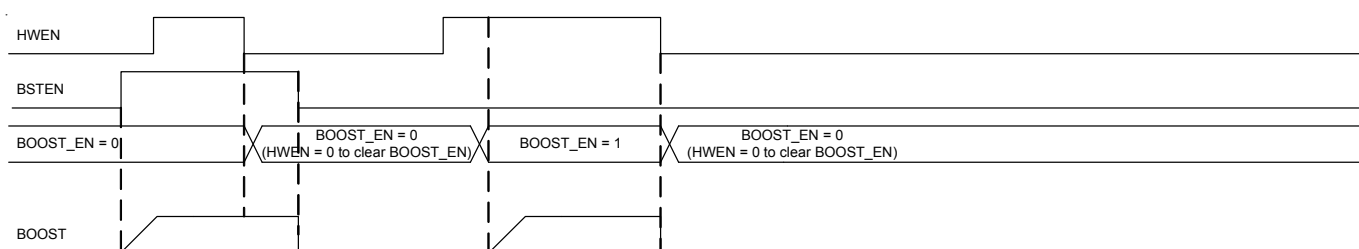

Figure 10.

Example for normal control with combination of BSTEN pin and EN bits. BSTEN pin is able to control Boost regardless of HWEN state.

**Output Voltage Setting**

The RT5112H output voltage can be programmed via I<sup>2</sup>C with dedicated registers.

• **Buck**

Register 0x0C[7:0] is used to control Buck output voltage.

Register 0x14[7:6] is used to control Buck voltage scaling slew rate.

• **Boost**

Register 0x11[7:2] is used to control Boost output voltage.

Register 0x14[3:2] is used to control Boost voltage scaling slew rate.

• **LDOs**

Registers 0x0D[7:1], 0x0E[7:1], 0x0F[7:1], 0x10[7:1] are used to control LDO1, LDO2, LDO3 and LDO4 output voltage.

Register 0x14[5:4] is used to control LDOs voltage scaling slew rate.

**Operating Mode**

The RT5112H provides different operating modes for Buck, Boost and LDOs for flexible application. Registers 0x00[1:0], 0x01[1:0], 0x02[1:0], 0x03[1:0], 0x04[1:0] and 0x05[1:0] are used to control the operating mode.

• **Buck and Boost**

▶ **Auto PFM (Pulse Frequency Modulation) Mode**

In order to save power and improve efficiency at low loads, the Buck/ Boost operate in PFM mode as the inductor drops into DCM (Discontinuous Current Mode). The switching frequency is proportional to loading to reach output voltage regulation. When load increases and inductor current becomes continuous again, the Buck/ Boost automatically goes back to PWM fixed frequency mode. Additionally, the RT5112H will enters DSLP (Deep Sleep) to reach input low quiescent current at no load.

### ▶ FPWM (Forced Pulse Width Modulation) Mode

The switching frequency is forced into PWM mode operation. In this mode, the inductor current is in CCM (Continuous Current Mode) and the voltage is regulated by PWM.

### ▶ Normal Mode

The operation is same as Auto PFM mode. The only one difference is that there is no DSLP in this mode.

### ▶ Ultra-Sonic Mode

To avoid acoustic noise problem when operation, the switching frequency is designed to be always higher than 20kHz even there is no load at output.

## ● LDOs

### ▶ Auto Mode

This mode is for general use.

### ▶ EN Forced Mode

When EN Forced Mode is selected, the RT5112H can provide higher PSRR (Power Supply Rejection Ratio) to mitigate interference from input voltage. However, it brings out higher quiescent current to get the function.

### ▶ Bypass Mode

LDO internal power MOSFET is fully turned on. Input voltage will pass through it to the output terminal directly.

## Operating Mode for NFC module (Only Boost)

The RT5112H provides two ways to avoid Boost switching frequency situated at around  $847 \pm 106$ kHz during NFC module operation duration. Registers 0x05[6] and 0x39[2] are used to select the method.

### ● Auto NFC (0x05[6] = 1, 0x39[2] = 0)

When switching frequency is close to 600kHz (typ.), the RT5112H will activate Auto NFC function to increase the switching frequency to around 1.1MHz (typ.). When the switching frequency continues to increase to 1.6MHz (typ.) with increasing load, it will leave Auto NFC mechanism. If the present switching frequency is situated at range 600kHz to 1.1MHz when leaving, it will re-activate Auto NFC function to increase switching frequency again. Once the present switching frequency

(depends on load) is always higher than 1.6MHz, it goes back to normal operating.

### ● FCCM NFC (0x05[6] = 0, 0x39[2] = 1)

When the loading is increased to 130mA (typ.), the RT5112H will activate FCCM NFC function to transit Boost into FPWM mode operation. The operating switching frequency is 3MHz (typ.) which is much higher than  $847 \pm 106$ kHz to interfere NFC module.

## Channel Protection Features

The RT5112H equips Over-Current Protection, Under-Voltage Protection and Over-Voltage Protection to prevent the device from damages causing by abnormal operation or fault conditions. (over-load, short-circuit, soldering issue...etc.)

### ● Over-Current Protection (OCP)

#### ▶ Behavior after OCP

Register 0x37[7:5] is used to select the operation after over-current failure detected.

#### ▶ OCP Mechanism

##### ◆ Buck

When the inductor current reaches the high-side MOSFET peak current limit threshold, the high-side MOSFET will be turned-off. The low-side MOSFET turns on to discharge the inductor current until the inductor current trips below the low-side MOSFET valley current limit threshold. After high-side MOSFET peak current limit triggered, the maximum inductor current is decided by the inductor current rising rate and the response delay time of the internal network.

##### ◆ Boost

When the loading current is increased such that the inductor current is above the high-side MOSFET valley current limit threshold, the off-time is increased until the inductor current is decreased to valley current threshold. The maximum inductor current is decided by the high-side MOSFET valley current limit level and internal designed inductor current ripple.

◆ **LDOs**

When the loading reaches the current limit threshold, the current sent to the output will kept at current limit level.

● **Under-Voltage Protection (UVP)**

▶ **Behavior after UVP**

Register 0x0A[7:5] is used to select the operation after under voltage failure detected.

● **Ovrt-Voltage Protection (OVP)**

▶ **Behavior after OVP**

Register 0x0A[2:0] is used to select the operation after over voltage failure detected.

**Table 3. Protection**

Channel	Type	Threshold (typ.)	Deglintch Time (typ.)	Protection	Reset and Threshold (typ.)
System	UVLO	$V_{SYS} < 2.35V$ $V_{SYS} \leq 2.25V$ (after IC Operation)	525 $\mu$ s	IC Shutdown	$V_{SYS} \geq 2.35V$
	OVP	$V_{SYS} \geq 5.9V$	200 $\mu$ s	Buck Disable	$V_{SYS} \leq 5.6V$
	OTW	Temperature $\geq 125^{\circ}C$	50 $\mu$ s	Report only	Temperature $\leq 105^{\circ}C$
	OTP	Temperature $\geq 140^{\circ}C$	50 $\mu$ s	IC Shutdown	Selection by 0x0A[4:3] 00 : Manual recovery after TSD with reset register 01 : Auto recovery after TSD with no reset register 10 : Latch off after TSD with reset register
BUCK	UVP	$V_{BUCK} \leq V_{BUCK\_SET} \times 80\%$	50 $\mu$ s	Selection by 0x0A[7] 0 : Hiccup mode 1 : Latch-off mode	$V_{BUCK} \geq V_{BUCK\_SET} \times 92\%$
	OVP	$V_{BUCK} \geq V_{BUCK\_SET} \times 120\%$	50 $\mu$ s	Selection by 0x0A[2] 0 : Discharge mode 1 : Latch-off mode	$V_{BUCK} \leq V_{BUCK\_SET} \times 109\%$
	OCP	$I_{LXBUCK\_peak} \geq 2A$ $I_{LXBUCK\_valley} \geq 1.5A$ (peak - 0.5A)	8 $\mu$ s	Selection by 0x037[7] 0 : Hiccup mode 1 : Latch-off mode	$I_{LXBUCK\_peak} < 2A$ $I_{LXBUCK\_valley} < 1.5A$ (peak - 0.5A)
BOOST	UVP	$V_{BOOST} \leq V_{BOOST} \times 80\%$	50 $\mu$ s	Selection by 0x0A[5] 0 : Hiccup mode 1 : Latch-off mode	$V_{BOOST} \geq V_{BOOST} \times 92.3\%$
	OVP	$V_{BOOST} \geq V_{BOOST} \times 117\%$	8 $\mu$ s	Selection by 0x0A[0] 0 : NA 1 : Latch-off mode	$V_{BOOST} \leq V_{BOOST} \times 106\%$
	ABS OVP	$V_{BOOST} \geq 6.5V$	8 $\mu$ s	Stop switch	$V_{BOOST} \leq 5.8V$
	OCP	$I_{LXBOOST\_valley} \geq 2.5A$	8 $\mu$ s	Selection by 0x037[5] 0 : Hiccup mode 1 : Latch-off mode	$I_{LXBOOST\_valley} < 2.5A$

Channel	Type	Threshold (typ.)	Deglintch Time (typ.)	Protection	Reset and Threshold (typ.)
LDOs	UVP	$V_{LDO} \leq V_{LDO} \times 80\%$	50 $\mu$ s	Selection by 0x0A[6] 0 : Hiccup mode 1 : Latch-off mode	$V_{LDO} \geq V_{LDO} \times 90\%$
	OVP	$V_{LDO} \geq V_{LDO} \times 120\%$	50 $\mu$ s	Selection by 0x0A[1] 0 : Discharge mode 1 : NA	$V_{LDO} \leq V_{LDO} \times 110\%$
	OCP	$I_{LDO} > 415\text{mA}$	8 $\mu$ s	Selection by 0x037[6] 0 : Hiccup mode 1 : Latch-off mode	$I_{LDO} \leq 415\text{mA}$

**Interrupt**

• **Fault Event and Status**

The RT5112H interrupt controller continuously monitors the device operation. Once the fault is ever detected, the fault event bit will be set to 1 and the open drain interrupt indicate pin INTRB will be driven to ground level. Meanwhile, the fault status bit will also be set to 1 to show the present fault. When the host reads the fault event bit and set interrupt clear bit 0x14[0] = 1, the INTRB pin will be released to high impedance. The fault status bit goes back to 0 only till the fault condition is cleared.

**Table 4. Interrupt**

Fault Event	Fault Status	Description
BUCK_UV_EVT 0x15[7]	BUCK_UV_STAT 0x2B[7]	BUCK output under-voltage
LDO1_UV_EVT 0x15[6]	LDO1_UV_STAT 0x2B[6]	LDO1 output under-voltage
LDO2_UV_EVT 0x15[5]	LDO2_UV_STAT 0x2B[5]	LDO2 output under-voltage
LDO3_UV_EVT 0x15[4]	LDO3_UV_STAT 0x2B[4]	LDO3 output under-voltage
LDO4_UV_EVT 0x15[3]	LDO4_UV_STAT 0x2B[3]	LDO4 output under-voltage
BOOST_UV_EVT 0x15[2]	BOOST_UV_STAT 0x2B[2]	BOOST output under-voltage
BOOST_FAULT_EVT 0x15[0]	BOOST_FAULT_STAT 0x2B[0]	BOOST internal fault
BUCK_OV_EVT 0x16[7]	BUCK_OV_STAT 0x2C[7]	BUCK output over-voltage
LDO1_OV_EVT 0x16[6]	LDO1_OV_STAT 0x2C[6]	LDO1 output over-voltage
LDO2_OV_EVT 0x16[5]	LDO2_OV_STAT 0x2C[5]	LDO2 output over-voltage
LDO3_OV_EVT 0x16[4]	LDO3_OV_STAT 0x2C[4]	LDO3 output over-voltage
LDO4_OV_EVT 0x16[3]	LDO4_OV_STAT 0x2C[3]	LDO4 output over-voltage
BOOST_OV_EVT 0x16[2]	BOOST_OV_STAT 0x2C[2]	BOOST output over-voltage
BUCK_OCP_EVT 0x17[7]	BUCK_OCP_STAT 0x2D[7]	BUCK over-current
LDO1_OCP_EVT 0x17[6]	LDO1_OCP_STAT 0x2D[6]	LDO1 over-current
LDO2_OCP_EVT 0x17[5]	LDO2_OCP_STAT 0x2D[5]	LDO2 over-current
LDO3_OCP_EVT 0x17[4]	LDO3_OCP_STAT 0x2D[4]	LDO3 over-current



Fault Event	Fault Status	Description
LDO4_OCP_EVT 0x17[3]	LDO4_OCP_STAT 0x2D[3]	LDO4 over-current
BOOST_OCP_EVT 0x17[2]	BOOST_OCP_STAT 0x2D[2]	BOOST over-current
TWARN_EVT 0x19[7]	TWARN_STAT 0x2F[7]	Thermal warning
TSD_EVT 0x19[6]	TSD_STAT 0x2F[6]	Thermal shutdown
VSYSUV_EVT 0x19[5]	VSYSUV_STAT 0x2F[5]	System under-voltage
VSYSOV_EVT 0x19[4]	VSYSOV_STAT 0x2B[4]	System over-voltage

**Fault Event Mask**

The host can set the fault event mask bits to hide the fault events. When the mask bit is set to 1, the corresponding fault is hidden and the interrupt indicate pin INTRB will keep high impedance without being pulled to ground level. The host requires to read the fault event bits to clear its value to 0, otherwise the interrupt indicate pin INTRB will be driven to low level again when mask bits being set to 1. The mask bits will be reset to default value with conditions : HWEN voltage goes to low level or IC power shutdown.

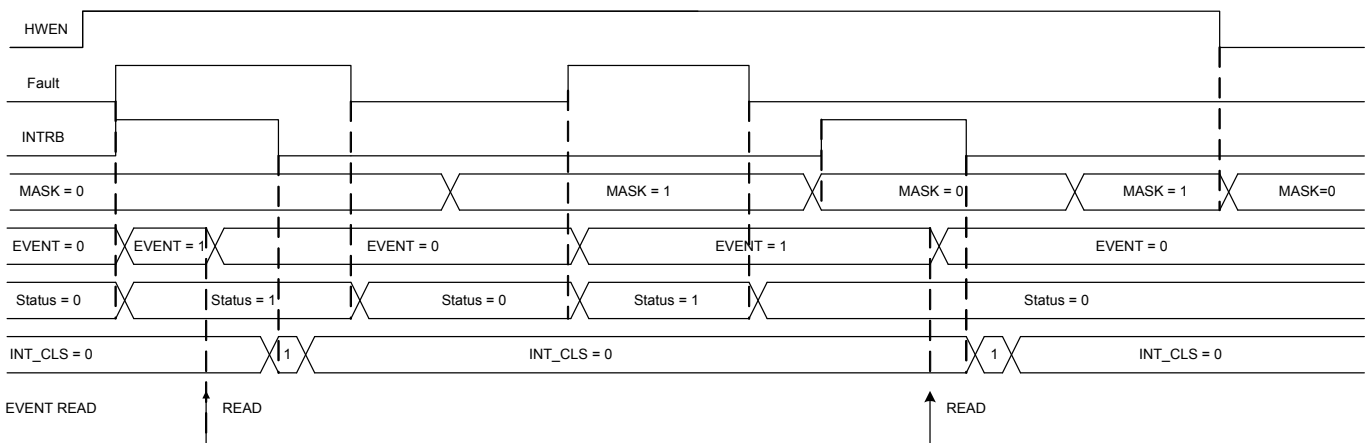

Figure 11.

**Component Selection**

**Inductor Selection**

The recommended nominal inductance 1μH/0.47μH for Buck/ Boost converter. The inductor saturation current must be chosen carefully considering the current limit level. It is suggested to select an inductor with the low DCR to provide good performance and efficiency for application.

**Input and Output Capacitor Selection**

**Buck and Boost**

It is recommended at least a 10μF (6.3V) input capacitor for Buck and Boost, a 10μF (6.3V) output

capacitor for Buck and a 22μF (6.3V) output capacitor for Boost. The ripple voltage is an important index for choosing output capacitor. This portion consists of two parts. One is the product of ripple current with the ESR of the output capacitor, while the other part is formed by the charging and discharging process of the output capacitor. The output ripple can be calculated as below.

**Buck**

$$\Delta V_{OUT} = \Delta V_{ESR} + \Delta V_{OUT1} + \frac{\Delta I_L}{8 \times C_{OUT} \times f_{SW}}$$

where  $\Delta V_{ESR} = I_{COUT\_RMS} \times R_{COUT\_ESR}$

**◆ Boost**

$$\Delta V_{OUT} = \Delta V_{ESR} + \Delta V_{OUT1} = \Delta V_{ESR} + \frac{I_{OUT} \times D}{f_{SW} \times C_{OUT}}$$

where  $\Delta V_{ESR} = I_{COUT\_RMS} \times R_{COUT\_ESR}$

**▶ LDOs**

Like any low dropout regulator, the external capacitors of the RT5112H must be carefully selected for regulator stability and performance. Using a capacitor of at least 2.2 $\mu$ F (X5R or X7R) is suitable.

## I<sup>2</sup>C Interface

The following table shows the RT5112H unique address as below.

RT5112H I <sup>2</sup> C Slave Address			
MSB	LSB	R/W bit	R/W
010000	0	1/0	41/40

The I<sup>2</sup>C interface bus must be connect a resistor 2.2kΩ to power node and independent connection to processor, individually. The I<sup>2</sup>C timing diagrams are listed below.

Read N bytes from the RT5112H

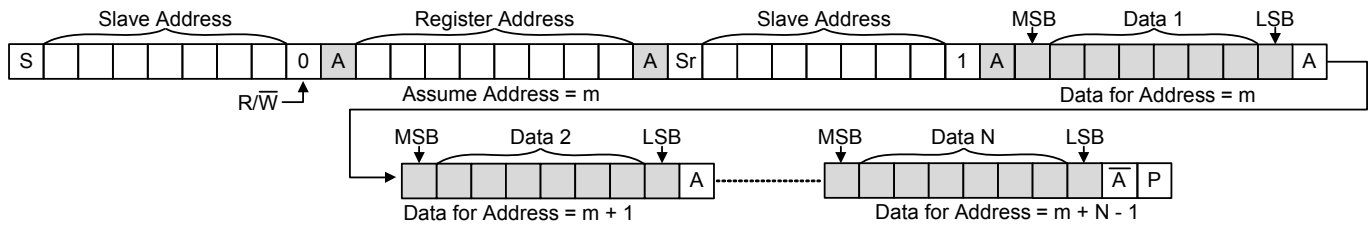

Write N bytes to the RT5112H

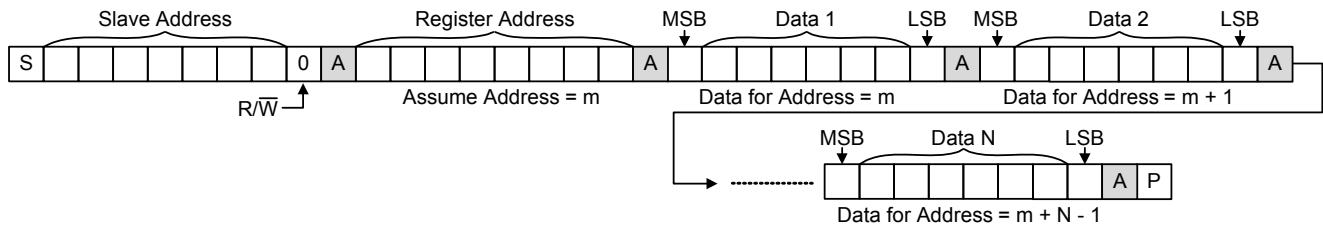

□ Driven by Master, ■ Driven by Slave, □ P Stop, □ S Start, □ Sr Repeat Start

## I<sup>2</sup>C Waveform Information

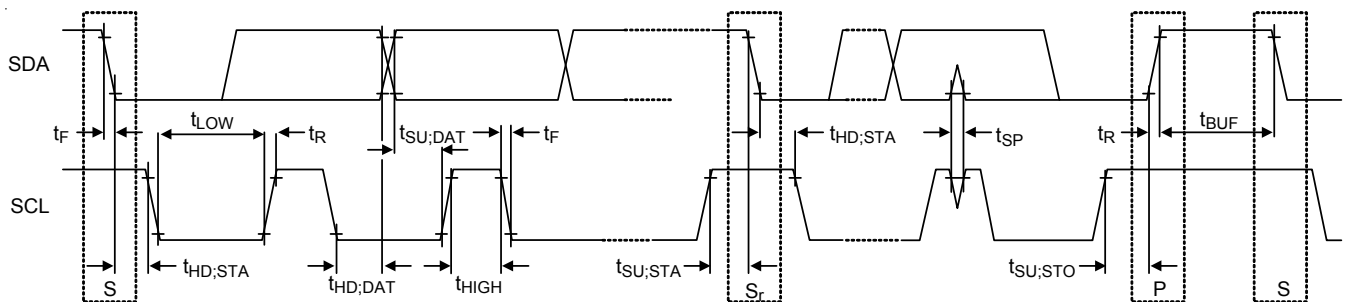

## I<sup>2</sup>C Register Table

R : Read only.

RC : Read then Clear.

RW : Read and Write.

WC : Write "1" then clear to "0" after this procedure finish.

Note :

(1) Below registers setting are only available on the RT5112A.

0x06, 0x0B[2], 0x12, 0x13[5:4], 0x15[1], 0x16[1], 0x17[1], 0x2B[1], 0x2C[1], 0x2D[1], 0x30[1], 0x32[1], 0x33[1], 0x34[1], 0x3B[1], 0x43[4]

(2) Boost related registers setting below are kept when Boost is disabled by BSTEN signal.

0x05[6], 0x05[1:0], 0x08, 0x11[7:2], 0x13[1:0]

Addr	RegName	Bit	BitName	Default	Type	Description
0x00	Buck_CTRL	7	BUCK_EN	0	RW	Buck enable. This bit is mask if REG0x00[6:4] : BUCK_DELAY ≠ 3'b000 0 : Disable (default) 1 : Enable Note : When Buck's latch-off protection happen, this bit will reset to "0"
		6:4	BUCK_DELAY	000	RW	Buck power on/off delay time setting: 000 : Controlled by I <sup>2</sup> C with REG0x00[7] : BUCK_EN (default) 001 : SLOT1 010 : SLOT2 011 : SLOT3 100 : SLOT4 101 : SLOT5 110 : SLOT6 111 : SLOT7 (delay time setting at on/off sequence are reverse) Note : When Buck's latch-off protection happen, these bits will reset to "000"
		3:2	BUCK_ILIM	01	RW	Buck current limit set bit. 00 : 1.5A 01 : 2A (default) 10 : 2.5A 11 : 3A
		1:0	BUCK_MODE	00	RW	Buck operation mode : 00 : Auto PFM mode (default) 01 : Forced PWM mode 10 : Ultra sonic mode 11 : Normal mode

Addr	RegName	Bit	BitName	Default	Type	Description
0x01	LDO1_CTRL	7	LDO1_EN	0	RW	LDO1 enable. This bit is mask if REG0x01[6:4] : LDO1_DELAY $\neq$ 3'b000 0 : Disable (default) 1 : Enable Note : When LDO1's latch-off protection happen, this bit will reset to "0"
		6:4	LDO1_DELAY	000	RW	LDO1 power on/off delay time setting: 000 : Controlled by I <sup>2</sup> C with REG0x01[7] : LDO1_EN (default) 001 : SLOT1 010 : SLOT2 011 : SLOT3 100 : SLOT4 101 : SLOT5 110 : SLOT6 111 : SLOT7 (delay time setting at on/off sequence are reverse) Note : When LDO1's latch-off protection happen, these bits will reset to "000"
		3:2	LDO1_ILIM	11	RW	LDO1 current limit set bit. 00 : 150mA 01 : 250mA 10 : 300mA 11 : 360mA (default)
		1:0	LDO1_MODE	00	RW	LDO1 operation mode : 00 : Auto mode (default) 01 : EN forced mode. (High PSRR mode). 10 : Bypass mode. LDO1 internal power MOSFET turns on fully. 11 : Bypass mode. LDO1 internal power MOSFET turns on fully.

Addr	RegName	Bit	BitName	Default	Type	Description
0x02	LDO2_CTRL	7	LDO2_EN	0	RW	LDO2 enable. This bit is mask if REG0x02[6:4] : LDO2_DELAY $\neq$ 3'b000 0 : Disable (default) 1 : Enable Note : When LDO2's latch-off protection happen, this bit will reset to "0"
		6:4	LDO2_DELAY	000	RW	LDO2 power on/off delay time setting : 000 : Controlled by I <sup>2</sup> C with REG0x02[7] : LDO2_EN (default) 001 : SLOT1 010 : SLOT2 011 : SLOT3 100 : SLOT4 101 : SLOT5 110 : SLOT6 111 : SLOT7 (delay time setting at on/off sequence are reverse) Note : When LDO2's latch-off protection happen, these bits will reset to "000"
		3:2	LDO2_ILIM	11	RW	LDO2 current limit set bit. 00 : 150mA 01 : 250mA 10 : 300mA 11 : 360mA (default)
		1:0	LDO2_MODE	00	RW	LDO2 operation mode : 00 : Auto mode (default) 01 : EN forced mode. (High PSRR mode). 10 : Bypass mode. LDO2 internal power MOSFET turns on fully. 11 : Bypass mode. LDO2 internal power MOSFET turns on fully.

Addr	RegName	Bit	BitName	Default	Type	Description
0x03	LDO3_CTRL	7	LDO3_EN	0	RW	LDO3 enable. This bit is mask if REG0x03[6:4] : LDO3_DELAY $\neq$ 3'b000 0 : Disable (default) 1 : Enable Note : When LDO3's latch-off protection happen, this bit will reset to "0"
		6:4	LDO3_DELAY	000	RW	LDO3 power on/off delay time setting : 000 : Controlled by I <sup>2</sup> C with REG0x03[7] : LDO3_EN (default) 001 : SLOT1 010 : SLOT2 011 : SLOT3 100 : SLOT4 101 : SLOT5 110 : SLOT6 111 : SLOT7 (delay time setting at on/off sequence are reverse) Note : When LDO3's latch-off protection happen, these bits will reset to "000"
		3:2	LDO3_ILIM	11	RW	LDO3 Current limit set bit. 00 : 150mA 01 : 250mA 10 : 300mA 11 : 360mA (default)
		1:0	LDO3_MODE	00	RW	LDO3 operation mode : 00 : Auto mode (default) 01 : EN forced mode. (High PSRR mode). 10 : Bypass mode. LDO3 internal power MOSFET turns on fully. 11 : Bypass mode. LDO3 internal power MOSFET turns on fully.

Addr	RegName	Bit	BitName	Default	Type	Description
0x04	LDO4_CTRL	7	LDO4_EN	0	RW	LDO4 enable. This bit is mask if REG0x04[6:4] : LDO4_DELAY $\neq$ 3'b000 0 : Disable (default) 1 : Enable Note : When LDO4's latch-off protection happen, this bit will reset to "0"
		6:4	LDO4_DELAY	000	RW	LDO4 power on/off delay time setting : 000 : Controlled by I <sup>2</sup> C with REG0x04[7] : LDO4_EN (default) 001 : SLOT1 010 : SLOT2 011 : SLOT3 100 : SLOT4 101 : SLOT5 110 : SLOT6 111 : SLOT7 (delay time setting at on/off sequence are reverse) Note : When LDO4's latch-off protection happen, these bits will reset to "000"
		3:2	LDO4_ILIM	11	RW	LDO4 current limit set bit. 00 : 150mA 01 : 250mA 10 : 300mA 11 : 360mA (default)
		1:0	LDO4_MODE	00	RW	LDO4 operation mode : 00 : Auto mode (default) 01 : EN forced mode. (High PSRR mode). 10 : Bypass mode. LDO4 internal power MOSFET turns on fully. 11 : Bypass mode. LDO4 internal power MOSFET turns on fully.



Addr	RegName	Bit	BitName	Default	Type	Description
0x05	BOOST_CTRL	7	LCH_ON	0	RW	Boost linear charge current : 0 : 400mA (default) 1 : 800mA
		6	NFC_EN	1	RW	Boost NFC enable. 0x39[2] must set 0 when bit NFC_EN = 1. 0 : Disable 1 : Enable (default)
		5:4	BOOST_SS	00	RW	Voltage scaling slew rate for Boost. 00 : 14mV/μs (default) 01 : 10mV/μs 10 : 6mV/μs 11 : 4mV/μs
		3:2	BOOST_ILIM	01	RW	Boost current limit set bit. 00 : 2A 01 : 2.5A (default) 10 : 3A 11 : 3.5A
		1:0	BOOST_MODE	00	RW	Boost operation mode: 00 : Auto PFM mode (default) 01 : Forced PWM mode 10 : Ultra sonic mode 11 : Normal mode

Addr	RegName	Bit	BitName	Default	Type	Description
0x06	Buck2_CTRL	7	BUCK2_EN	0	RW	BUCK2 enable. This bit is mask if REG0x06[6:4] : BUCK2_DELAY ≠ 3'b000 0 : Disable (default) 1 : Enable Note : When Buck2's latch-off protection happen, this bit will reset to "0"
		6:4	BUCK2_DELAY	000	RW	BUCK2 power on/off delay time setting : 000 : Controlled by I <sup>2</sup> C with REG0x06[7] : BUCK2_EN (default) 001 : SLOT1 010 : SLOT2 011 : SLOT3 100 : SLOT4 101 : SLOT5 110 : SLOT6 111 : SLOT7 (delay time setting at on/off sequence are reverse) Note : When Buck2's latch-off protection happen, these bits will reset to "000"
		3:2	BUCK2_ILIM	01	RW	BUCK2 current limit set bit. 00 : 1.5A 01 : 2A (default) 10 : 2.5A 11 : 3A
		1:0	BUCK2_MODE	00	RW	BUCK2 operation mode: 00 : Auto mode (default) 01 : Forced PWM mode 10 : Ultra sonic mode 11 : Normal mode

Addr	RegName	Bit	BitName	Default	Type	Description
0x07	Product ID	7:0	PID	11001101	R	Vendor identification

Addr	RegName	Bit	BitName	Default	Type	Description
0x08	BOOST_ENABLE	7	BOOST_EN7	0	RW	Enable bit #7 for the Boost. 0 : Disable (default) 1 : Enable
		6	BOOST_EN6	0	RW	Enable bit #6 for the Boost. 0 : Disable (default) 1 : Enable
		5	BOOST_EN5	0	RW	Enable bit #5 for the Boost. 0 : Disable (default) 1 : Enable
		4	BOOST_EN4	0	RW	Enable bit #4 for the Boost. 0 : Disable (default) 1 : Enable
		3	BOOST_EN3	0	RW	Enable bit #3 for the Boost. 0 : Disable (default) 1 : Enable
		2	BOOST_EN2	0	RW	Enable bit #2 for the Boost. 0 : Disable (default) 1 : Enable
		1	BOOST_EN1	0	RW	Enable bit #1 for the Boost. 0 : Disable (default) 1 : Enable
		0	BOOST_EN0	0	RW	Enable bit #0 for the Boost. 0 : Disable (default) 1 : Enable

Addr	RegName	Bit	BitName	Default	Type	Description
0x09	SEQ_PROG	7:6	SEQ_SPE ED[1:0]	10	RW	Set slot period : 00 : 2.73ms 01 : 1.365ms 10 : 0.682ms (default) 11 : 0.341ms (slot period is the base unit of each SLOT, for example SLOT2 = 2*slot period; SLOT3 = 3*slot period) Set soft-start time slew rate (Buck_SR) : 00 : 1mV/μs 01 : 2mV/μs 10 : 4mV/μs (default) 11 : 7mV/μs (Buck's VOUT min. step = 12.5mV, f = 2.5MHz) (Once slot period is chose, corresponding soft start time slew rate is determined.) Note : Buck soft-start time (Buck_tss) 00 : 1ms/V x Vout 01 : 0.5ms/V x Vout 10 : 0.25ms/V x Vout (default) 11 : 0.143ms/V x Vout
		5:4	SEQ_ CTRL[1:0]	10	RW	2 bits to control LDOs and Buck's ON/OFF 00 : Power-Down, relative regulators (CHx_DELAY ≠ 3'b000) disable by power off sequence, others turn off by each EN bit 01 : Power-UP, relative regulators (CHx_DELAY ≠ 3'b000) enable by power on sequence, others turn on by each EN bit 10 : All regulators's ON/OFF depend on each EN bit. (default) 11 : All regulators turn off directly.
		3:0	Reserved	0000	RW	Reserved

Addr	RegName	Bit	BitName	Default	Type	Description
0x0A	Latch	7	BUCK_UV_LATCH	0	RW	Buck hiccup or latch off mode selection after V <sub>O</sub> UV. 0 : Hiccup mode; (continuously hiccup more than 3 times would enter latch-off mode ,select deglitch time by REG0x38[7:6], hiccup on/off time = 5/8ms) (default) 1 : Latch-off mode
		6	LDO_UV_LATCH	0	RW	LDO hiccup or latch off mode selection after V <sub>O</sub> UV. 0 : Hiccup mode; (continuously hiccup more than 3 times would enter latch-off mode ,select deglitch time by REG0x38[3:2], hiccup on/off time = 5/40ms) (default) 1 : Latch-off mode
		5	BOOST_UV_LATCH	0	RW	Boost hiccup or latch off mode selection after V <sub>O</sub> UV. 0 : Hiccup mode; (continuously hiccup more than 3 times would enter latch-off mode ,select deglitch time by REG0x37[3:2], hiccup on/off time = 11/100ms) (default) 1 : Latch-off mode
		4:3	TSD[1:0]	01	RW	IC protection after thermal shutdown : 00 : Manual recovery after TSD with reset I <sup>2</sup> C register. The power up sequence is initiated with default I <sup>2</sup> C register value 01 : Auto recovery after TSD with no reset I <sup>2</sup> C register. The power up sequence is initiated with I <sup>2</sup> C register value (default) 10 : Latch off after TSD, all Reg reset. Restart by Vin start up or (BSTEN = 0 → 1 to restart Boost) or (HWEN = 0 → 1 to enable channel), i.e.BSTEN and HWEN need pull low to unlock 11 : No change, follow before setting
		2	BUCK_OV_LATCH	0	RW	Buck discharge or latch off mode selection after V <sub>O</sub> OV. 0 : R Discharge (default) 1: Latch-off mode
		1	LDO_OV_LATCH	0	RW	LDO discharge mode selection after V <sub>O</sub> OV. 0 : R Discharge; (During DVS period won't sent OV Event to INTRB) (default) 1 : NA
		0	BOOST_OV_LATCH	0	RW	Boost latch off mode selection after V <sub>O</sub> OV. 0 : NA (default) 1 : Latch-off mode

Addr	RegName	Bit	BitName	Default	Type	Description
0x0B	DISCHARGE	7	BUCK_DIS	1	RW	Buck active output discharge. 0 : Disable 1 : Enable (default)
		6	LDO_DIS	1	RW	LDO active output discharge. 0 : Disable 1 : Enable (default)
		5	BOOST_DIS	1	RW	Boost active output discharge. 0 : Disable 1 : Enable (default)
		4	Reserved	0	RW	Reserved
		3	Reserved	0	RW	Reserved
		2	BUCK2_DIS	1	RW	Buck2 active output discharge. 0 : Disable 1 : Enable (default)
		1	BCTRL	0	WC	Boost registers keep and reset control. Self reset function: it can recover to 0 when set 1 : 0 : Keep Boost relative Reg value Register0x05[7], 0x05[5:2], 0x08[7:0], 0x0A[5], 0x0A[0], 0x14[3:2], 0x37[5], 0x37[3:2] Boost relative bits. (default) 1 : Boost relative Reg recover to default value. When HWEN OFF and BCTRL = 0 (default), Boost keeps relative Reg. When HWEN ON and BCTRL = 1, Boost recover to default value. BCTRL become 0 automatically, Boost relative Reg is kept. When HWEN ON and BCTRL = 0, Boost relative can be written normally. When write 1 then it will recover to 0.
		0	Reserved	0	RW	Reserved

Addr	RegName	Bit	BitName	Default	Type	Description
0x0C	Buck_Vout	7:0	Buck_Vout [7:0]	00101000	RW	Buck output voltage can be set default voltage from 0.8V to 3.3V with 12.5mV/step. 00000000 : 0.6V 00000001 : 0.6125V ... 00101000 : 1.1V (default) ... 11010111 : 3.2875V 11011000 : 3.3V ... 11111111 : 3.3V

Addr	RegName	Bit	BitName	Default	Type	Description
0x0D	LDO1_Vout	7:1	LDO1_Vout[6:0]	1011000	RW	LDO1 output voltage can be set default voltage from 0.6V to 3.775V with 25mV/step. 0000000 : 0.6V 0000001 : 0.625V ... 1011000 : 2.8V (default) ... 1111110 : 3.75V 1111111 : 3.775V
		0	Reserved	0	RW	Reserved

Addr	RegName	Bit	BitName	Default	Type	Description
0x0E	LDO2_Vout	7:1	LDO2_Vout[6:0]	1011000	RW	LDO2 output voltage can be set default voltage from 0.6V to 3.775V with 25mV/step. 0000000 : 0.6V 0000001 : 0.625V ... 1011000 : 2.8V (default) ... 1111110 : 3.75V 1111111 : 3.775V
		0	Reserved	0	RW	Reserved

Addr	RegName	Bit	BitName	Default	Type	Description
0x0F	LDO3_Vout	7:1	LDO3_Vout[6:0]	0110000	RW	LDO3 output voltage can be set default voltage from 0.6V to 3.775V with 25mV/step. 0000000 : 0.6V 0000001 : 0.625V ... 0110000 : 1.8V (default) ... 1111110 : 3.75V 1111111 : 3.775V
		0	Reserved	0	RW	Reserved

Addr	RegName	Bit	BitName	Default	Type	Description
0x10	LDO4_Vout	7:1	LDO4_Vout[6:0]	0110000	RW	LDO4 output voltage can be set default voltage from 0.6V to 3.775V with 25mV/step. 0000000 : 0.6V 0000001 : 0.625V ... 0110000 : 1.8V (default) ... 1111110 : 3.75V 1111111 : 3.775V
		0	Reserved	0	RW	Reserved

Addr	RegName	Bit	BitName	Default	Type	Description
0x11	Boost_Vout	7:2	Boost_Vout[5:0]	010100	RW	Boost output voltage can be set default voltage from 4.5V to 5.5V with 25mV/step. 000000 : 4.5V 000001 : 4.525V ... 010100: 5.0V (default) ... 100111: 5.475V 101000: 5.5V ... 111111: 5.5V
		1:0	LDO_SS	01	RW	Voltage scaling slew rate for LDO. 00 : 100mV/μs 01 : 50mV/μs (default) 10 : 25mV/μs 11 : 12.5mV/μs

Addr	RegName	Bit	BitName	Default	Type	Description
0x12	Buck2_Vout	7:0	Buck2_Vout[7:0]	10110100	RW	Buck2 output voltage can be set default voltage from 0.6V to 3.3V with 12.5mV/step. 00000000 : 0.6V 00000001 : 0.6125V ... 10110100 : 2.85V (default) ... 11010111 : 3.2875V 11011000 : 3.3V ... 11111111: 3.3V



Addr	RegName	Bit	BitName	Default	Type	Description
0x13	LX_SR	7:6	Buck_SR [1:0]	01	RW	Buck SW on/off speed set. Decrease SW speed can help the EMI performance. 00 : Slower 01 : Slow (default) 10 : Normal 11 : Fast
		5:4	Buck2_SR [1:0]	01	RW	Buck2 SW on/off speed set. Decrease SW speed can help the EMI performance. 00 : Slower 01 : Slow (default) 10 : Normal 11 : Fast
		3	Reserved	0	RW	Reserved
		2	Reserved	0	RW	Reserved
		1:0	Boost_SR [1:0]	10	RW	Boost SW on/off speed set. Decrease SW speed can help the EMI performance. 00 : Fast 01 : Normal 10 : Slow (default) 11 : Slower

Addr	RegName	Bit	BitName	Default	Type	Description
0x14	DVS	7:6	BUCK_DVS	01	RW	Voltage scaling slew rate for Buck. 00 : 7mV/μs 01 : 4mV/μs (default) 10 : 2mV/μs 11 : 1mV/μs
		5:4	LDO_DVS	01	RW	Voltage scaling slew rate for LDO. 00 : 36mV/μs 01 : 14mV/μs (default) 10 : 8.5mV/μs 11 : 4mV/μs
		3:2	BOOST_DVS	01	RW	Voltage scaling slew rate for Boost. 00 : 32mV/μs 01 : 15mV/μs (default) 10 : 8mV/μs 11 : 4mV/μs
		1	Reserved	0	RW	Reserved
		0	INT_CLS	0	WC	Interrupt clear pin. 0 : Normal operation (default) 1 : Refresh interrupt bits. (After write "1", the bit will auto return to "0".)

Addr	RegName	Bit	BitName	Default	Type	Description
0x15	UV_EVT	7	BUCK_UV_EVT	0	RC	Buck under-voltage threshold sense acknowledgement. (raising trigger) 0 : No fault or be masked (default) 1 : Buck UV event detected
		6	LDO1_UV_EVT	0	RC	LDO1 under-voltage threshold sense acknowledgement. (raising trigger) 0 : No fault or be masked (default) 1 : LDO1 UV event detected
		5	LDO2_UV_EVT	0	RC	LDO2 under-voltage threshold sense acknowledgement. (raising trigger) 0 : No fault or be masked (default) 1 : LDO2 UV event detected
		4	LDO3_UV_EVT	0	RC	LDO3 under-voltage threshold sense acknowledgement. (raising trigger) 0 : No fault or be masked (default) 1 : LDO3 UV event detected
		3	LDO4_UV_EVT	0	RC	LDO4 under-voltage threshold sense acknowledgement. (raising trigger) 0 : No fault or be masked (default) 1 : LDO4 UV event detected
		2	BOOST_UV_EVT	0	RC	Boost under-voltage threshold sense acknowledgement. (raising trigger) 0 : No fault or be masked (default) 1 : Boost UV event detected
		1	BUCK2_UV_EVT	0	RC	Buck2 under-voltage threshold sense acknowledgement. (raising trigger) 0 : No fault or be masked (default) 1 : Buck2 UV event detected
		0	BOOST_FAULT_EVT	0	RC	Boost SCP (VOUT < 0.7V) or VDS protect (VIN – VOUT > 300mV) or IL > 5A internal Boost FAULT 0 : Not fault or be masked (default) 1 : Boost fault event detected

Addr	RegName	Bit	BitName	Default	Type	Description
0x16	OV_EVT	7	BUCK_OV_EVT	0	RC	Buck over-voltage threshold sense acknowledgement. (raising trigger) 0 : No fault or be masked (default) 1 : Buck OV event detected
		6	LDO1_OV_EVT	0	RC	LDO1 over-voltage threshold sense acknowledgement. (raising trigger) 0 : No fault or be masked (default) 1 : LDO1 OV event detected
		5	LDO2_OV_EVT	0	RC	LDO2 over-voltage threshold sense acknowledgement. (raising trigger) 0 : No fault or be masked (default) 1 : LDO2 OV event detected
		4	LDO3_OV_EVT	0	RC	LDO3 over-voltage threshold sense acknowledgement. (raising trigger) 0 : No fault or be masked (default) 1 : LDO3 OV event detected
		3	LDO4_OV_EVT	0	RC	LDO4 over-voltage threshold sense acknowledgement. (raising trigger) 0 : No fault or be masked (default) 1 : LDO4 OV event detected
		2	BOOST_OV_EVT	0	RC	Boost over-voltage threshold sense acknowledgement. (raising trigger) 0 : No fault or be masked (default) 1 : Boost OV event detected
		1	BUCK2_OV_EVT	0	RC	Buck2 over-voltage threshold sense acknowledgement. (raising trigger) 0 : No fault or be masked (default) 1 : Buck2 OV event detected
		0	Reserved	0	RC	Reserved

Addr	RegName	Bit	BitName	Default	Type	Description
0x17	OCP_EVT	7	BUCK_OCP_EVT	0	RC	Buck over-current protection acknowledgement. (raising trigger) 0 : No fault or be masked (default) 1 : Buck OCP event detected
		6	LDO1_OCP_EVT	0	RC	LDO1 over-current protection acknowledgement. (raising trigger) 0 : No fault or be masked (default) 1 : LDO1 OCP event detected
		5	LDO2_OCP_EVT	0	RC	LDO2 over-current protection acknowledgement. (raising trigger) 0 : No fault or be masked (default) 1 : LDO2 OCP event detected
		4	LDO3_OCP_EVT	0	RC	LDO3 over-current protection acknowledgement. (raising trigger) 0 : No fault or be masked (default) 1 : LDO3 OCP event detected
		3	LDO4_OCP_EVT	0	RC	LDO4 over-current protection acknowledgement. (raising trigger) 0 : No fault or be masked (default) 1 : LDO4 OCP event detected
		2	BOOST_OCP_EVT	0	RC	Boost over-current protection acknowledgement. (raising trigger) 0 : No fault or be masked (default) 1 : Boost OCP event detected
		1	BUCK2_OCP_EVT	0	RC	Buck2 over-current protection acknowledgement. (raising trigger) 0 : No fault or be masked (default) 1 : Buck2 OCP event detected
		0	Reserved	0	RC	Reserved

Addr	RegName	Bit	BitName	Default	Type	Description
0x19	BASE_EVT	7	TWARN_EVT	0	RC	Thermal warning sense acknowledgement. (raising/falling trigger) 0 : No fault or be masked (default) 1 : Thermal warning event detected
		6	TSD_EVT	0	RC	Thermal shutdown sense acknowledgement. (raising/falling trigger) 0 : No fault or be masked (default) 1 : Thermal shutdown event detected
		5	VSYSUV_EVT	0	RC	VSYS under-voltage sense acknowledgement. (raising trigger) 0 : No fault or be masked (default) 1 : Under-voltage event detected
		4	VSYSOV_EVT	0	RC	VSYS over-voltage sense acknowledgement. (raising trigger) 0 : No fault or be masked (default) 1 : Over-voltage event detected
		3:0	Reserved	0000	RC	Reserved

Addr	RegName	Bit	BitName	Default	Type	Description
0x2A	Revision ID	7:0	RID[7:0]	00000011	R	Chip revision 00000000 : 1 <sup>st</sup> Version 00000001 : 2 <sup>nd</sup> Version 00000010 : 3 <sup>rd</sup> Version 00000011 : 4 <sup>th</sup> Version (default) ... 11111111 : 256 <sup>th</sup> Version

Addr	RegName	Bit	BitName	Default	Type	Description
0x2B	UV_STAT	7	BUCK_UV_STAT	0	R	Buck under-voltage threshold sense status. 0 : No fault occurs (default) 1 : Fault occurs
		6	LDO1_UV_STAT	0	R	LDO1 under-voltage threshold sense status. 0 : No fault occurs (default) 1 : Fault occurs
		5	LDO2_UV_STAT	0	R	LDO2 under-voltage threshold sense status. 0 : No fault occurs (default) 1 : Fault occurs
		4	LDO3_UV_STAT	0	R	LDO3 under-voltage threshold sense status. 0 : No fault occurs (default) 1 : Fault occurs
		3	LDO4_UV_STAT	0	R	LDO4 under-voltage threshold sense status. 0 : No fault occurs (default) 1 : Fault occurs
		2	BOOST_UV_STAT	0	R	Boost under-voltage threshold sense status. 0 : No fault occurs (default) 1 : Fault occurs
		1	BUCK2_UV_STAT	0	R	Buck2 under-voltage threshold sense status. 0 : No fault occurs (default) 1 : Fault occurs
		0	BOOST_FAULT_STAT	0	R	Boost SCP (VOOUT < 0.7V) or VDS protect (VIN – VOOUT > 300mV) or IL > 5A internal boost FAULT status. 0 : No fault occurs (default) 1 : Fault occurs

Addr	RegName	Bit	BitName	Default	Type	Description
0x2C	OV_STAT	7	BUCK_OV_STAT	0	R	Buck over-voltage threshold sense status. 0 : No fault occurs (default) 1 : Fault occurs
		6	LDO1_OV_STAT	0	R	LDO1 over-voltage threshold sense status. 0 : No fault occurs (default) 1 : Fault occurs
		5	LDO2_OV_STAT	0	R	LDO2 over-voltage threshold sense status. 0 : No fault occurs (default) 1 : Fault occurs
		4	LDO3_OV_STAT	0	R	LDO3 over-voltage threshold sense status. 0 : No fault occurs (default) 1 : Fault occurs
		3	LDO4_OV_STAT	0	R	LDO4 over-voltage threshold sense status. 0 : No fault occurs (default) 1 : Fault occurs
		2	BOOST_OV_STAT	0	R	Boost over-voltage threshold sense status. 0 : No fault occurs (default) 1 : Fault occurs
		1	BUCK2_OV_STAT	0	R	Buck2 over-voltage threshold sense status. 0 : No fault occurs (default) 1 : Fault occurs
		0	Reserved	0	R	Reserved

Addr	RegName	Bit	BitName	Default	Type	Description
0x2D	OCP_STAT	7	BUCK_OCP_STAT	0	R	Buck over-current protection status. 0 : No fault occurs (default) 1 : Fault occurs
		6	LDO1_OCP_STAT	0	R	LDO1 over-current protection status. 0 : No fault occurs (default) 1 : Fault occurs
		5	LDO2_OCP_STAT	0	R	LDO2 over-current protection status. 0 : No fault occurs (default) 1 : Fault occurs
		4	LDO3_OCP_STAT	0	R	LDO3 over-current protection status. 0 : No fault occurs (default) 1 : Fault occurs
		3	LDO4_OCP_STAT	0	R	LDO4 over-current protection status. 0 : No fault occurs (default) 1 : Fault occurs
		2	BOOST_OCP_STAT	0	R	Boost over-current protection status. 0 : No fault occurs (default) 1 : Fault occurs
		1	BUCK2_OCP_STAT	0	R	Buck2 over-current protection status. 0 : No fault occurs (default) 1 : Fault occurs
		0	Reserved	0	R	Reserved

Addr	RegName	Bit	BitName	Default	Type	Description
0x2F	BASE_STAT	7	TWARN_STAT	0	R	Thermal warning sense status. 0 : No fault occurs (default) 1 : Fault occurs
		6	TSD_STAT	0	R	Thermal shutdown sense status. 0 : No fault occurs (default) 1 : Fault occurs
		5	VSYSUV_STAT	0	R	VSYS under-voltage sense status. 0 : No fault occurs (default) 1 : Fault occurs
		4	VSYSOV_STAT	0	R	VSYS over-voltage sense status. 0 : No fault occurs (default) 1 : Fault occurs
		3	SEQ_ON	0	R	It indicates status of the internal SEQ_ON signal. 0 : SEQ OFF (default) 1 : SEQ ON
		2:0	Reserved	000	R	Reserved

Addr	RegName	Bit	BitName	Default	Type	Description
0x30	EN_FLG	7	BUCK_EN_FLG	0	R	Indicate Buck final enable status. 0 : Disable (default) 1 : Enable
		6	LDO1_EN_FLG	0	R	Indicate LDO1 final enable status. 0 : Disable (default) 1 : Enable
		5	LDO2_EN_FLG	0	R	Indicate LDO2 final enable status. 0 : Disable (default) 1 : Enable
		4	LDO3_EN_FLG	0	R	Indicate LDO3 final enable status. 0 : Disable (default) 1 : Enable
		3	LDO4_EN_FLG	0	R	Indicate LDO4 final enable status. 0 : Disable (default) 1 : Enable
		2	BOOST_EN_FLG	0	R	Indicate BOOST final enable status. 0 : Disable (default) 1 : Enable
		1	BUCK2_EN_FLG	0	R	Indicate Buck2 final enable status. 0 : Disable (default) 1 : Enable
		0	Reserved	0	R	Reserved



Addr	RegName	Bit	BitName	Default	Type	Description
0x32	UV_MASK	7	BUCK_UV_MASK	0	RW	Buck under-voltage threshold mask. 0 : Interrupt is not masked (default) 1 : Interrupt is masked
		6	LDO1_UV_MASK	0	RW	LDO1 under-voltage threshold sense mask. 0 : Interrupt is not masked (default) 1 : Interrupt is masked
		5	LDO2_UV_MASK	0	RW	LDO2 under-voltage threshold sense mask. 0 : Interrupt is not masked (default) 1 : Interrupt is masked
		4	LDO3_UV_MASK	0	RW	LDO3 under-voltage threshold sense mask. 0 : Interrupt is not masked (default) 1 : Interrupt is masked
		3	LDO4_UV_MASK	0	RW	LDO4 under-voltage threshold sense mask. 0 : Interrupt is not masked (default) 1 : Interrupt is masked
		2	BOOST_UV_MASK	0	RW	Boost under-voltage threshold sense mask. 0 : Interrupt is not masked (default) 1 : Interrupt is masked
		1	BUCK2_UV_MASK	0	RW	Buck2 under-voltage threshold sense mask. 0 : Interrupt is not masked (default) 1 : Interrupt is masked
		0	BOOST_FAULT_MASK	0	RW	Boost SCP (VOUT < 0.7V) or VDS protect (VIN – VOUT > 300mV) or IL > 5A internal boost FAULT mask. 0 : Interrupt is not masked (default) 1 : Interrupt is masked

Addr	RegName	Bit	BitName	Default	Type	Description
0x33	OV_MASK	7	BUCK_OV_MASK	0	RW	Buck over-voltage threshold mask. 0 : Interrupt is not masked (default) 1 : Interrupt is masked
		6	LDO1_OV_MASK	0	RW	LDO1 over-voltage threshold mask. 0 : Interrupt is not masked (default) 1 : Interrupt is masked
		5	LDO2_OV_MASK	0	RW	LDO2 over-voltage threshold mask. 0 : Interrupt is not masked (default) 1 : Interrupt is masked
		4	LDO3_OV_MASK	0	RW	LDO3 over-voltage threshold mask. 0 : Interrupt is not masked (default) 1 : Interrupt is masked
		3	LDO4_OV_MASK	0	RW	LDO4 over-voltage threshold mask. 0 : Interrupt is not masked (default) 1 : Interrupt is masked
		2	BOOST_OV_MASK	0	RW	Boost over-voltage threshold mask. 0 : Interrupt is not masked (default) 1 : Interrupt is masked
		1	BUCK2_OV_MASK	0	RW	Buck2 over-voltage threshold mask. 0 : Interrupt is not masked (default) 1 : Interrupt is masked
		0	Reserved	0	RW	Reserved

Addr	RegName	Bit	BitName	Default	Type	Description
0x34	OCP_MASK	7	BUCK_OCP_MASK	0	RW	Buck over-current protection mask. 0 : Interrupt is not masked (default) 1 : Interrupt is masked
		6	LDO1_OCP_MASK	0	RW	LDO1 over-current protection mask. 0 : Interrupt is not masked (default) 1 : Interrupt is masked
		5	LDO2_OCP_MASK	0	RW	LDO2 over-current protection mask. 0 : Interrupt is not masked (default) 1 : Interrupt is masked
		4	LDO3_OCP_MASK	0	RW	LDO3 over-current protection mask. 0 : Interrupt is not masked (default) 1 : Interrupt is masked
		3	LDO4_OCP_MASK	0	RW	LDO4 over-current protection mask. 0 : Interrupt is not masked (default) 1 : Interrupt is masked
		2	BOOST_OCP_MASK	0	RW	Boost over-current protection mask. 0 : Interrupt is not masked (default) 1 : Interrupt is masked
		1	BUCK2_OCP_MASK	0	RW	Buck2 over-current protection mask. 0 : Interrupt is not masked (default) 1 : Interrupt is masked
		0	Reserved	0	RW	Reserved

Addr	RegName	Bit	BitName	Default	Type	Description
0x36	BASE_MASK	7	TWARN_MASK	0	RW	Thermal warning sense mask. 0 : Interrupt is not masked (default) 1 : Interrupt is masked
		6	TSD_MASK	0	RW	Thermal shutdown sense mask. 0 : Interrupt is not masked (default) 1 : Interrupt is masked
		5	VSYSUV_MASK	0	RW	VSYS under-voltage sense mask. 0 : Interrupt is not masked (default) 1 : Interrupt is masked
		4	VSYSOV_MASK	0	RW	VSYS over-voltage sense mask. 0 : Interrupt is not masked (default) 1 : Interrupt is masked
		3:0	Reserved	0000	RW	Reserved

Addr	RegName	Bit	BitName	Default	Type	Description
0x37	CHx_PT	7	BUCK_OC_LATCH	0	RW	Buck Hiccup or latch off mode selection after current limit. 0 : Hiccup mode; (Hiccup 3 times will enter latch-off mode. Hiccup on/off time = 4ms / 8ms) (default) 1 : Latch-off mode.
		6	LDO_OC_LATCH	0	RW	LDO Hiccup or latch off mode selection after current limit. 0 : Hiccup mode; (Hiccup 3 times will enter latch-off mode. Hiccup on/off time = 2ms/40ms) (default) 1 : Latch-off mode.
		5	BOOST_OC_LATCH	0	RW	BOOST Hiccup or latch off mode selection after current limit. 0 : Hiccup mode; (Hiccup 3 times will enter latch-off mode, hiccup on/off time = 10ms/100ms) (default) 1 : Latch-off mode.
		4	Reserved	0	RW	Reserved
		3:2	BST_UV_DT[1:0]	11	RW	Boost UV deglitch time selection : 00 : 10μs 01 : 15μs 10 : 25μs 11 : 50μs (default)
		1:0	Reserved	00	RW	Reserved

Addr	RegName	Bit	BitName	Default	Type	Description
0x38	CHx_deglitch time	7:6	Buck_UV_DT[1:0]	11	RW	Buck UV deglitch time selection : 00 : 5µs 01 : 10µs 10 : 15µs 11 : 50µs (default)
		5:4	Buck_OV_DT[1:0]	11	RW	Buck OV deglitch time selection : 00 : 10µs 01 : 15µs 10 : 20µs 11 : 50µs (default)
		3:2	LDO_UV_DT[1:0]	11	RW	LDO UV deglitch time selection : 00 : 10µs 01 : 15µs 10 : 30µs 11 : 50µs (default)
		1:0	LDO_OV_DT[1:0]	11	RW	LDO OV deglitch time selection : 00 : 5µs 01 : 10µs 10 : 25µs 11 : 50µs (default)

Addr	RegName	Bit	BitName	Default	Type	Description
0x39	BASEPT_deglitch time	7:6	VSYSUV_DT[1:0]	11	RW	VSYSUV deglitch time selection : 00 : 70µs 01 : 135µs 10 : 265µs 11 : 525µs (default)
		5:4	VSYSOV_DT[1:0]	10	RW	VSYSOV deglitch time selection: 00 : 20µs 01 : 50µs 10 : 180µs (default) 11 : 360µs
		3	VSYSOV_PT	0	RW	VSYSOV turn off Buck 0 : When Vsys_OV occur will turn off BCK (default) 1 : When Vsys_OV occur will not turn off BCK
		2	BST_NFC_Force	0	RW	NFC load detection. 0x05[6] must set 0 when bit BST_NFC_force = 1. 0 : AUTO NFC (default) 1 : FCCM by load, turn off NFC
		1	Reserved	0	RW	Reserved
		0	Reserved	0	RW	Reserved

Addr	RegName	Bit	BitName	Default	Type	Description
0x3A	SEQ_ON	7:6	SEQ_ON_STAT[1:0]	00	R	It indicates the states of power on sequence 00 : SEQ_ON hasn't started or needless (default) 01 : SEQ_ON is carrying out (During SLOT1 to SLOT8 + 4ms) 10 : There are fail soft-start channels during power on sequence 11 : SEQ_ON has completed
		5:3	SEQ_COUNT [2:0]	000	R	It indicates the fault SLOT during power on sequence at SEQ_ON_STAT = 2'b10 000 : SLOT1 (default) 001 : SLOT2 010 : SLOT3 011 : SLOT4 100 : SLOT5 101 : SLOT6 110 : SLOT7 111 : SEQ_ON has completed
		2:0	Reserved	000	R	Reserved

Addr	RegName	Bit	BitName	Default	Type	Description
0x3B	SSEND_CHx	7	sSSEND_BCK	0	R	It indicates Buck soft-start end or not 0 : Not soft-start end (default) 1 : Soft-start end
		6	sSSEND_LDO1	0	R	It indicates LDO1 soft-start end or not 0 : Not soft-start end (default) 1 : Soft-start end
		5	sSSEND_LDO2	0	R	It indicates LDO2 soft-start end or not 0 : Not soft-start end (default) 1 : Soft-start end
		4	sSSEND_LDO3	0	R	It indicates LDO3 soft-start end or not 0 : Not soft-start end (default) 1 : Soft-start end
		3	sSSEND_LDO4	0	R	It indicates LDO4 soft-start end or not 0 : Not soft-start end (default) 1 : Soft-start end
		2	sSSEND_BST	0	R	It indicates Boost soft-start end or not 0 : Not soft-start end (default) 1 : Soft-start end
		1	sSSEND_BCK2	0	R	It indicates Buck2 soft-start end or not 0 : Not soft-start end (default) 1 : Soft-start end
		0	Reserved	0	R	Reserved

Addr	RegName	Bit	BitName	Default	Type	Description
0x42	INT_SET	7:6	Reserved	00	RW	Reserved
		5:4	INT_DEG[1:0]	00	RW	Interrupt reflash pulse width timing. 00 : disable (default) 01 : 2µs 10 : 4µs 11 : 8µs
		3:0	SEQ_STAT[2:0]	0000	R	Indicate PMU's State 0000 : IDLE (default) 0001 : ONSEQ (slot1 to slot7 + 4ms, when 4ms clock end will trigger ONSEQ_END) 0010 : ONSEQ_END 0011 : ENSEQ 0100 : OFFSEQ 0101 : OFFSEQ_END (slot7 to slot1, when slot1 sequence end will trigger OFFSEQ_END) 1111 : Else

Addr	RegName	Bit	BitName	Default	Type	Description
0x43	PMU_STAT	7:0	PMU_STAT	00000000	R	BST latch off (BSTEN) 0 : Release (default) 1 : Latch off
						BST latch off (HWEN) 0 : Release (default) 1 : Latch off
						BCK1 latch off 0 : Release (default) 1 : Latch off
						BCK2 latch off 0 : Release (default) 1 : Latch off
						LDO1 latch off 0 : Release (default) 1 : Latch off
						LDO2 latch off 0 : Release (default) 1 : Latch off
						LDO3 latch off 0 : Release (default) 1 : Latch off
						LDO4 latch off 0 : Release (default) 1 : Latch off

**Thermal Considerations**

The junction temperature should never exceed the absolute maximum junction temperature  $T_{J(MAX)}$ , listed under Absolute Maximum Ratings, to avoid permanent damage to the device. The maximum allowable power dissipation depends on the thermal resistance of the IC package, the PCB layout, the rate of surrounding airflow, and the difference between the junction and ambient temperatures. The maximum power dissipation can be calculated using the following formula :

$$P_{D(MAX)} = (T_{J(MAX)} - T_A) / \theta_{JA}$$

where  $T_{J(MAX)}$  is the maximum junction temperature,  $T_A$  is the ambient temperature, and  $\theta_{JA}$  is the junction-to-ambient thermal resistance.

For continuous operation, the maximum operating junction temperature indicated under Recommended Operating Conditions is 125°C. The junction-to-ambient thermal resistance,  $\theta_{JA}$ , is highly package dependent. For a WL-CSP-25B 2.2x2.3 (BSC) package, the thermal resistance,  $\theta_{JA}$ , is 31.5°C/W on a standard JEDEC 51-7 high effective-thermal-conductivity four-layer test board. The maximum power dissipation at  $T_A = 25^\circ\text{C}$  can be calculated as below :

$$P_{D(MAX)} = (125^\circ\text{C} - 25^\circ\text{C}) / (31.5^\circ\text{C/W}) = 3.05\text{W for a WL-CSP-25B 2.2x2.3 (BSC) package.}$$

The maximum power dissipation depends on the operating ambient temperature for the fixed  $T_{J(MAX)}$  and the thermal resistance,  $\theta_{JA}$ . The derating curves in Figure 12 allows the designer to see the effect of rising ambient temperature on the maximum power dissipation.

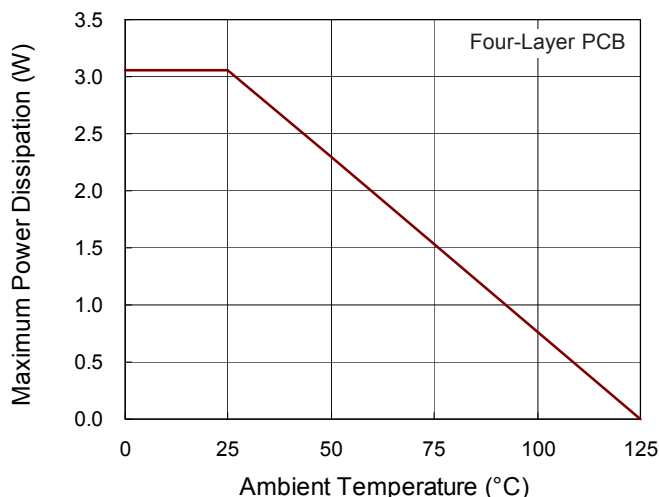

Figure 12. Derating Curve of Maximum Power Dissipation

**Layout Considerations**

The PCB layout is an important step to maintain the high performance of the RT5112H. Both the high current and the fast switching nodes demand full attention to the PCB layout to keep the robustness of the RT5112H through the PCB layout. Improper layout might lead to the symptoms of poor line or load regulation, ground and output voltage shifts, stability issues, unsatisfying EMI behavior or worsened efficiency. For the best performance of the RT5112H, the following PCB layout guidelines must be strictly followed.

- ▶ The trace from switching node to inductor should be as short as possible to minimized the switching loop for better EMI.
- ▶ Place the input and output capacitors close to the input and output pins respectively for good filtering.
- ▶ Keep the main power traces as wide and short as possible.
- ▶ Connect the AGND, DGND, GNDB and GNDBST to a strong ground plane for maximum thermal dissipation and noise protection.
- ▶ Directly connect the Buck output capacitors to the feedback network to avoid bouncing caused by parasitic resistance and inductance from the PCB trace.

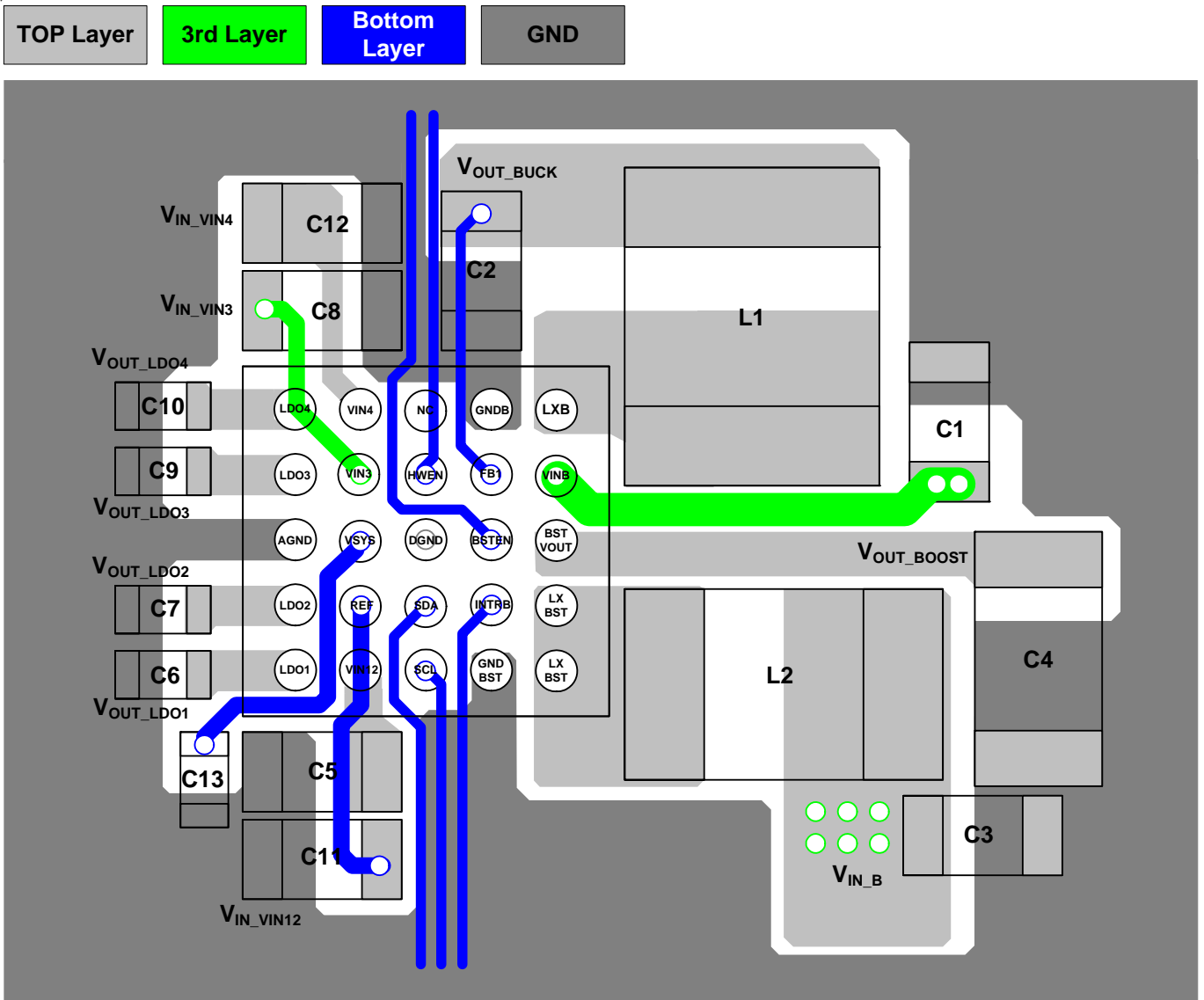
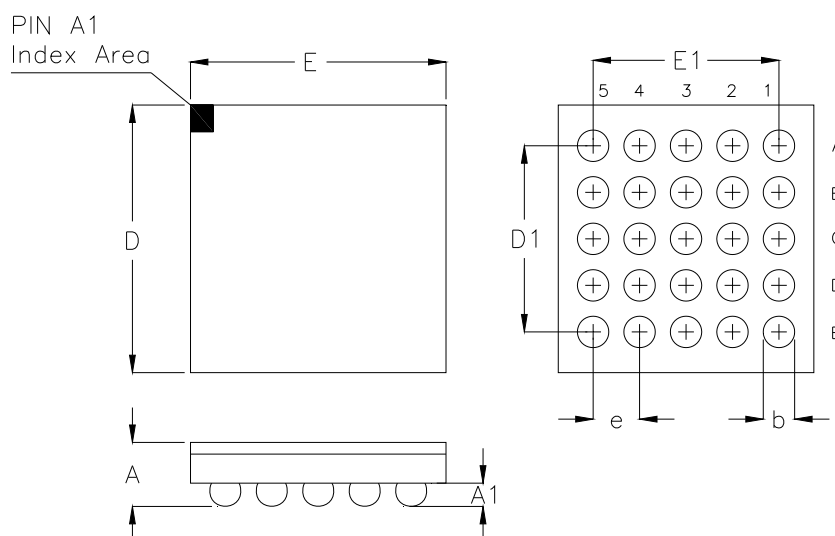

Figure 13. PCB Layout Guide



**Outline Dimension**



Symbol	Dimensions In Millimeters		Dimensions In Inches	
	Min	Max	Min	Max
A	0.500	0.600	0.020	0.024
A1	0.170	0.230	0.007	0.009
b	0.240	0.300	0.009	0.012
D	2.260	2.340	0.089	0.092
D1	1.600		0.063	
E	2.160	2.240	0.085	0.088
E1	1.600		0.063	
e	0.400		0.016	

**25B WL-CSP 2.2x2.3 Package (BSC)**

## Footprint Information

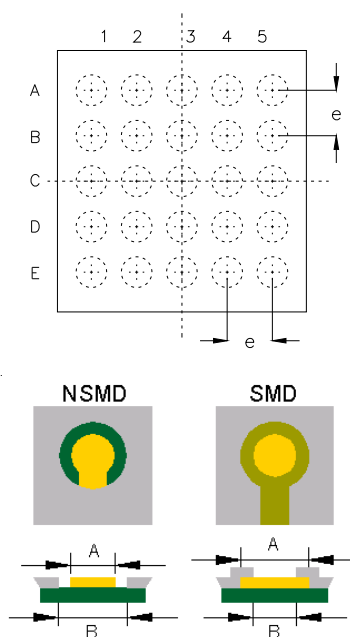

Package	Number of Pin	Type	Footprint Dimension (mm)			Tolerance
			e	A	B	
WL-CSP2.2x2.3-25(BSC)	25	NSMD	0.400	0.240	0.340	±0.025
		SMD		0.270	0.240	

### Richtek Technology Corporation

14F, No. 8, Tai Yuen 1<sup>st</sup> Street, Chupei City

Hsinchu, Taiwan, R.O.C.

Tel: (8863)5526789

Richtek products are sold by description only. Richtek reserves the right to change the circuitry and/or specifications without notice at any time. Customers should obtain the latest relevant information and data sheets before placing orders and should verify that such information is current and complete. Richtek cannot assume responsibility for use of any circuitry other than circuitry entirely embodied in a Richtek product. Information furnished by Richtek is believed to be accurate and reliable. However, no responsibility is assumed by Richtek or its subsidiaries for its use; nor for any infringements of patents or other rights of third parties which may result from its use. No license is granted by implication or otherwise under any patent or patent rights of Richtek or its subsidiaries.