

PIN A1
Index Area

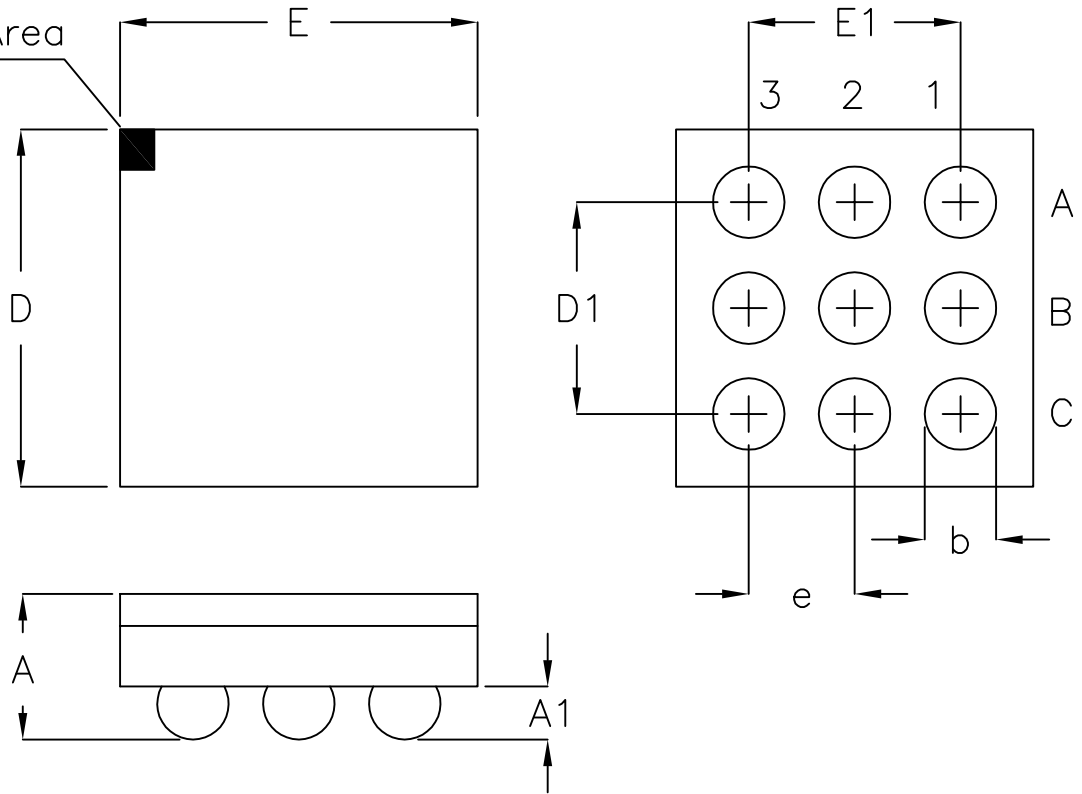

Symbol	Dimensions In Millimeters		Dimensions In Inches	
	Min.	Max.	Min.	Max.
A	0.500	0.600	0.020	0.024
A1	0.170	0.230	0.007	0.009
b	0.240	0.300	0.009	0.012
D	1.300	1.400	0.051	0.055
D1	0.800		0.031	
E	1.300	1.400	0.051	0.055
E1	0.800		0.031	
e	0.400		0.016	